



Solutions sur mesure pour votre usinage  
*Machining solutions especially for you*

# FRAISES À FILETER

## PAR INTERPOLATION

```
ONE PASS INCREMENTAL PROGRAM  
S #DIV/0! M03 M08 G94  
G91 X0 Y0 Z0  
G01 Z- #DIV/0! F 25  
G41 X 0,0000 Y- 0,0000 I #DIV/0!  
G03 X 0,0000 Y 0,0000 I #DIV/0! I 0 J 0,0000 F #DIV/0!  
G03 X- 0,0000 Y 0,0000 I #DIV/0! I 0 J- 0,0000 J #DIV/0!  
G03 X- 0,0000 Y- 0,0000 I #DIV/0! I 0 J- 0,0000 J #DIV/0!  
G03 X 0,0000 Y 0,0000 I #DIV/0! I 0 J 0,0000 J #DIV/0!  
G03 X- 0,0000 Y 0,0000 I #DIV/0! I 0 J 0,0000 J #DIV/0!  
G01G40 X- 0,0000 Y- 0,0000 F 25  
G00 Z #DIV/0!  
TWO PASS INCREMENTAL PROGRAM  
S #DIV/0! M03 M08 S 14  
G91 X0 Y0 Z0  
G01 Z- #DIV/0! F 25  
G41 X #DIV/0! Y- #DIV/0! I #DIV/0!  
G42 X #DIV/0! Y #DIV/0! I #DIV/0! I 0 J 0,0000 F #DIV/0!  
G03 X 0 Y 0 I 0 J 0 I #DIV/0! I #DIV/0! I #DIV/0! I #DIV/0!  
G03 X- #DIV/0! Y #DIV/0! I #DIV/0! I #DIV/0! I #DIV/0!  
G01G40 X- #DIV/0!  
G01 Z- 0,0000 F 0,0000  
G41 X 0,0000 Y- 0,0000 I #DIV/0!  
G03 X 0,0000 Y 0,0000 I #DIV/0! I 0 J 0,0000 F #DIV/0!  
G03 X- 0,0000 Y 0,0000 I #DIV/0! I 0 J- 0,0000 J #DIV/0!  
G03 X- 0,0000 Y- 0,0000 I #DIV/0! I 0 J- 0,0000 J #DIV/0!  
G03 X 0,0000 Y 0,0000 I #DIV/0! I 0 J 0,0000 J #DIV/0!  
G03 X- 0,0000 Y 0,0000 I #DIV/0! I 0 J 0,0000 J #DIV/0!  
G01G40 X- 0,0000 Y- 0,0000 F 25  
G00 Z #DIV/0!
```

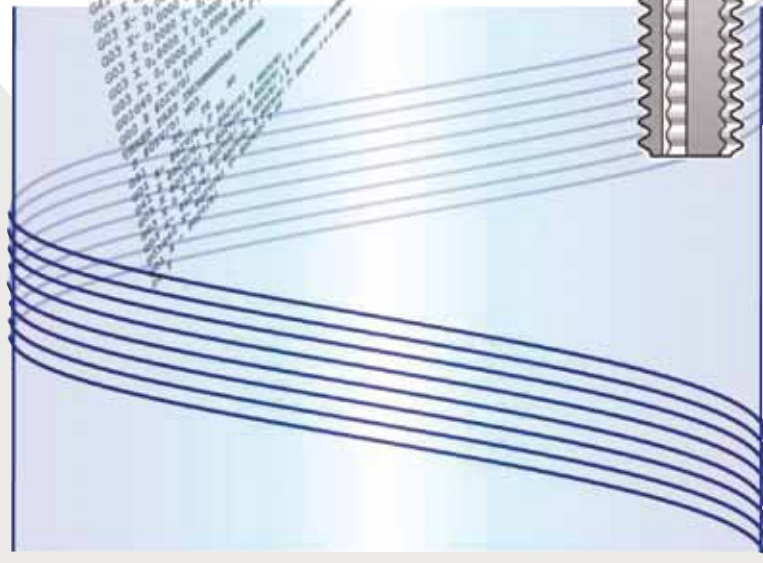

# Sommaire

## ■ Fraises à Fileter Carbone Monobloc

- Fraise à fileter ISO 60° intérieur **Page 04**
- Fraise à fileter ISO Pas Fin 60° intérieur **Page 04**
- Fraise à fileter ISO Pas Fin 60° extérieur **Page 04**
  
- Fraise à fileter UN 60° intérieur **Page 05**
- Fraise à fileter UN Pas Fin 60° intérieur **Page 05**
- Fraise à fileter UN Pas Fin 60° extérieur **Page 05**
  
- Fraise à fileter BSW 55° intérieur/extérieur **Page 06**
- Fraise à fileter BSP 55° intérieur/extérieur **Page 06**
- Fraise à fileter BSPT 55° intérieur/extérieur **Page 06**
- Fraise à fileter NPT 55° intérieur/extérieur **Page 06**
- Fraise à fileter NPTF 60° intérieur/extérieur **Page 06**
- Fraise à fileter PG 80° intérieur/extérieur **Page 06**
  
- Fraise à fileter T2 ISO 60° intérieur **Page 07**
- Fraise à fileter T2 ISO Pas Fin 60° intérieur **Page 07**
- Fraise à fileter T2 UN 60° intérieur **Page 07**
- Fraise à fileter T3 ISO 60° intérieur **Page 07**
- Fraise à fileter T3 ISO Pas Fin 60° intérieur **Page 07**
- Fraise à fileter T3 UN 60° intérieur **Page 07**
  
- Fraise à fileter Ø 35 à Alésage ISO & UN 60° intérieur **Page 08**
- Fraise à fileter Ø 45 à Alésage ISO & UN 60° intérieur **Page 08**
- Fraise à fileter Ø 55 à Alésage ISO & UN 60° intérieur **Page 08**

## ■ Fraises à fileter à plaquettes carbure indexable

- Plaquettes Carbure ISO 60° extérieur **Page 09**
- Plaquettes Carbure ISO 60° intérieur **Page 09**
- Plaquettes Carbure UN 60° extérieur **Page 09**
- Plaquettes Carbure UN 60° intérieur **Page 09**
  
- Plaquettes Carbure BSP 55° intérieur/extérieur **Page 10**
- Plaquettes Carbure NPSM 60° intérieur/extérieur **Page 10**
- Plaquettes Carbure NPSF 60° intérieur/extérieur **Page 10**
- Plaquettes Carbure BSPT 55° intérieur/extérieur **Page 10**
- Plaquettes Carbure NPT 60° intérieur/extérieur **Page 10**
- Plaquettes Carbure NPTF 6° intérieur/extérieur **Page 10**
  
- Fraise à Plaquettes Queue Cylindrique **Page 11**
- Fraise à Plaquettes à alésage **Page 11**
- Accessoires pour Fraise à Plaquettes **Page 11**

**Fraise ISO 60° / ISO pas fin** (*Standard Metric*) 

**Fraise UN 60° / UN pas fin** (*Unified National*) 

**FraiseBSW 55°** (*British Standard Witworth*)

**FraiseBSP 55°** (*British Standard Pipe*) 

**FraiseBSPT 55°** (*British Standard Pipe Taper*)

**Fraise NPT 55°** (*National Pipe*)

**Fraise NPTF 60°** (*National Pipe Taper*) 

**Fraise PG 80°**

**Fraise T2 ISO & UN** *Standard & Pas fin* 

**Fraise T3 ISO & UN** *Standard & Pas fin* 

**Fraise Ø 35 45 & 55 ISO & UN** 

**Plaquette carbure ISO & UN** 

**Plaquette BSP 55°** (*British Standard Pipe*)

**Plaquette NPSM 60°** (*National Pipe Straight Mechanical*) 

**Plaquette NPSF 60°** (*National Pipe Straight Dryseal*)

**Plaquette BSPT 55°** (*British Pipe Taper*)

**Plaquette NPT 60°** (*National Pipe*) 

**Plaquette NPTF 60°** (*National Pipe Taper*)

**Fraise à Plaquette QC** 

**Fraise à Plaquette à alésage**   

# ■ Fraise à Fileter

Carbure monobloc ISO 60°

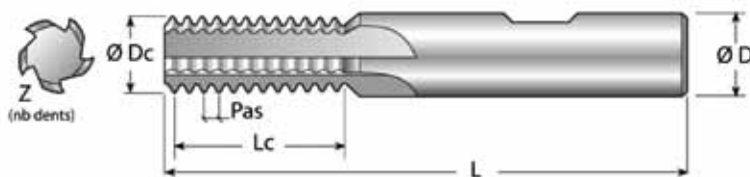

| ISO 60° |                   |      |                       |   |                      |            |       |       |           |
|---------|-------------------|------|-----------------------|---|----------------------|------------|-------|-------|-----------|
| NORME   | Référence Article |      | Z                     | L | Nb Filets / Lg coupe | Dc         | D     | Tarif |           |
| M 1.6   | x                 | 0.35 | TMSC 03010-N-0.35 ISO | 3 | 38                   | 7 - 2.45   | 1.00  | 3.00  |           |
| M 2     | x                 | 0.40 | TMSC 03013-N-0.40 ISO | 3 | 38                   | 8 - 3.20   | 1.30  | 3.00  |           |
| M 2.5   | x                 | 0.45 | TMSC 03015-N-0.45 ISO | 3 | 38                   | 8 - 3.60   | 1.50  | 3.00  |           |
| M 3     | x                 | 0.50 | TMSC 03021-N-0.50 ISO | 3 | 38                   | 9 - 4.50   | 2.10  | 3.00  |           |
| M 4     | x                 | 0.70 | TMSC 03026-N-0.70 ISO | 3 | 38                   | 9 - 6.30   | 2.60  | 3.00  |           |
| M 4.5   | x                 | 0.75 | TMSC 04030-N-0.75 ISO | 3 | 42                   | 9 - 6.75   | 3.00  | 4.00  | Nous      |
| M 5     | x                 | 0.80 | TMSC 04036-N-0.80 ISO | 3 | 42                   | 10 - 8.00  | 3.60  | 4.00  |           |
| M 6     | x                 | 1.00 | TMSC 06040-N-1.00 ISO | 3 | 57                   | 9 - 9.00   | 4.00  | 6.00  | Consulter |
| M 8     | x                 | 1.25 | TMSC 06050-N-1.25 ISO | 3 | 57                   | 10 - 12.50 | 5.00  | 6.00  |           |
| M 10    | x                 | 1.50 | TMSC 06059-N-1.50 ISO | 5 | 57                   | 10 - 15.00 | 5.90  | 6.00  |           |
| M 12    | x                 | 1.75 | TMSC 08079-N-1.75 ISO | 5 | 63                   | 11 - 19.25 | 7.90  | 8.00  |           |
| M 16    | x                 | 2.00 | TMSC 10099-N-2.00 ISO | 5 | 72                   | 12 - 24.00 | 9.90  | 10.00 |           |
| M 20    | x                 | 2.50 | TMSC 12119-N-2.50 ISO | 5 | 83                   | 12 - 30.00 | 11.90 | 12.00 |           |
| M 24    | x                 | 3.00 | TMSC 16159-N-3.00 ISO | 6 | 92                   | 12 - 36.00 | 15.90 | 16.00 |           |
| M 30*   | x                 | 3.50 | TMSC 16159-N-3.50 ISO | 6 | 92                   | 11 - 38.50 | 15.90 | 16.00 |           |
| M 36*   | x                 | 4.00 | TMSC 16159-N-4.00 ISO | 6 | 92                   | 10 - 40.00 | 15.90 | 16.00 |           |
| M 48*   | x                 | 5.00 | TMSC 20199-N-5.00 ISO | 6 | 104                  | 8 - 40.00  | 19.90 | 20.00 |           |
| M 64*   | x                 | 6.00 | TMSC 20199-N-6.00 ISO | 6 | 104                  | 6 - 36.00  | 19.90 | 20.00 |           |

| ISO 60° intérieur Pas Fin |                   |      |                       |   |                      |           |       |       |           |
|---------------------------|-------------------|------|-----------------------|---|----------------------|-----------|-------|-------|-----------|
| NORME                     | Référence Article |      | Z                     | L | Nb Filets / Lg coupe | Dc        | D     | Tarif |           |
| M 10                      | x                 | 0.50 | TMSC 08079-N-0.50 ISO | 5 | 63                   | 30 - 15.0 | 7.90  | 8.0   |           |
| M 10                      | x                 | 0.75 | TMSC 06059-N-0.75 ISO | 5 | 57                   | 20 - 15.0 | 5.90  | 6.0   |           |
| M 12                      | x                 | 1.00 | TMSC 08079-N-1.00 ISO | 5 | 63                   | 20 - 20.0 | 7.90  | 8.0   |           |
| M 16                      | x                 | 1.50 | TMSC 10099-N-1.50 ISO | 5 | 72                   | 16 - 24.0 | 9.90  | 10.0  | Nous      |
| M 18                      | x                 | 1.50 | TMSC 12119-N-1.50 ISO | 5 | 83                   | 20 - 30.0 | 11.90 | 12.0  |           |
| M 20                      | x                 | 2.00 | TMSC 12119-N-2.00 ISO | 5 | 83                   | 15 - 30.0 | 11.90 | 12.0  | Consulter |
| M 24                      | x                 | 3.00 | TMSC 16159-N-3.00 ISO | 6 | 92                   | 12 - 36.0 | 15.90 | 16.0  |           |
| M 36*                     | x                 | 4.00 | TMSC 16159-N-4.00 ISO | 6 | 92                   | 10 - 40.0 | 15.90 | 16.0  |           |
| M 64*                     | x                 | 6.00 | TMSC 20199-N-6.00 ISO | 6 | 104                  | 6 - 36.0  | 19.90 | 20.00 |           |

| ISO 60° extérieur Pas Fin |                   |      |                       |   |                      |           |       |       |           |
|---------------------------|-------------------|------|-----------------------|---|----------------------|-----------|-------|-------|-----------|
| NORME                     | Référence Article |      | Z                     | L | Nb Filets / Lg coupe | Dc        | D     | Tarif |           |
| M 3                       | x                 | 0.50 | TMSC 06059-E-0.50 ISO | 5 | 57                   | 30 - 15.0 | 5.90  | 6.0   |           |
| M 3                       | x                 | 0.50 | TMSC 08079-E-0.50 ISO | 5 | 63                   | 30 - 15.0 | 7.90  | 8.0   |           |
| M 4.5                     | x                 | 0.75 | TMSC 08079-E-0.75 ISO | 5 | 63                   | 26 - 19.5 | 7.90  | 8.0   |           |
| M 6                       | x                 | 1.00 | TMSC 10099-E-1.00 ISO | 5 | 72                   | 24 - 24.0 | 9.90  | 10.0  | Nous      |
| M 10                      | x                 | 1.50 | TMSC 12119-E-1.50 ISO | 5 | 72                   | 20 - 30.0 | 11.90 | 12.0  |           |
| M 14                      | x                 | 2.00 | TMSC 12119-E-2.00 ISO | 5 | 83                   | 15 - 30.0 | 11.90 | 12.0  | Consulter |
| M 24                      | x                 | 3.00 | TMSC 16159-E-3.00 ISO | 6 | 83                   | 12 - 36.0 | 15.90 | 16.0  |           |
| M 36*                     | x                 | 4.00 | TMSC 16159-E-4.00 ISO | 6 | 92                   | 10 - 40.0 | 15.90 | 16.0  |           |
| M 64*                     | x                 | 6.00 | TMSC 20199-E-6.00 ISO | 6 | 104                  | 6 - 36.00 | 19.90 | 20.00 |           |

# ■ Fraise à Fileter

## Carbure Monobloc UN 60°

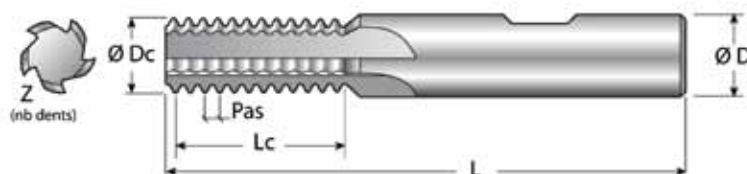

| UN 60°            |   |                   |                      |   |                      |             |       |       |           |
|-------------------|---|-------------------|----------------------|---|----------------------|-------------|-------|-------|-----------|
| NORME             |   | Référence Article | Z                    | L | Nb Filets / Lg coupe | Dc          | D     | Tarif |           |
| N° 2              | x | 0.397             | TMSC 03015-N-64" UN  | 3 | 38                   | 8 - 3.175   | 1.50  | 3.00  |           |
| N° 2              | x | 0.454             | TMSC 03015-N-56" UN  | 3 | 38                   | 7 - 3.175   | 1.50  | 3.00  |           |
| N° 3              | x | 0.529             | TMSC 03015-N-48" UN  | 3 | 38                   | 7 - 3.704   | 1.50  | 3.00  |           |
| N° 5              | x | 0.577             | TMSC 03021-N-44" UN  | 3 | 38                   | 8 - 4.618   | 2.10  | 3.00  |           |
| N° 4              | x | 0.635             | TMSC 03021-N-40" UN  | 3 | 38                   | 7 - 4.445   | 2.10  | 3.00  |           |
| N° 8              | x | 0.705             | TMSC 04030-N-36" UN  | 3 | 42                   | 9 - 6.350   | 3.00  | 4.00  |           |
| N° 8              | x | 0.794             | TMSC 04030-N-32" UN  | 3 | 42                   | 8 - 6.350   | 3.00  | 4.00  |           |
| N° 12             | x | 0.907             | TMSC 04036-N-28" UN  | 3 | 57                   | 9 - 8.165   | 3.60  | 4.00  |           |
| N° 12             | x | 1.058             | TMSC 06040-N-24" UN  | 3 | 57                   | 8 - 8.467   | 4.00  | 6.00  |           |
| 1 / 4 "           | x | 1.270             | TMSC 06040-N-20" UN  | 3 | 57                   | 8 - 10.160  | 4.00  | 6.00  | Nous      |
| 5 / 16 "          | x | 1.411             | TMSC 06050-N-18" UN  | 3 | 57                   | 9 - 12.700  | 5.00  | 6.00  |           |
| 3 / 8 "           | x | 1.587             | TMSC 06059-N-16" UN  | 5 | 57                   | 9 - 14.287  | 5.90  | 6.00  | Consulter |
| 7 / 16 "          | x | 1.814             | TMSC 08079-N-14" UN  | 5 | 63                   | 9 - 16.328  | 7.90  | 8.00  |           |
| 1 / 2 "           | x | 1.954             | TMSC 08079-N-13" UN  | 5 | 63                   | 10 - 19.538 | 7.90  | 8.00  |           |
| 9 / 16 "          | x | 2.116             | TMSC 10099-N-12" UN  | 5 | 72                   | 11 - 23.283 | 9.90  | 10.00 |           |
| 5 / 8 "           | x | 2.309             | TMSC 10099-N-11" UN  | 5 | 72                   | 10 - 23.091 | 9.90  | 10.00 |           |
| 3 / 4 "           | x | 2.500             | TMSC 12199-N-10" UN  | 5 | 83                   | 11 - 27.490 | 11.90 | 12.00 |           |
| 7 / 8 "           | x | 2.778             | TMSC 16159-N- 9" UN  | 6 | 92                   | 12 - 33.337 | 15.90 | 16.00 |           |
| 1 "               | x | 3.175             | TMSC 16159-N- 8" UN  | 6 | 92                   | 12 - 38.100 | 15.90 | 16.00 |           |
| 1 1/8 " - 1 1/4 " | x | 3.628             | TMSC 16159-N- 7" UN  | 6 | 92                   | 10 - 36.285 | 15.90 | 16.00 |           |
| 1 3/8 " - 1 1/2 " | x | 4.233             | TMSC 20199-N- 6" UN  | 6 | 104                  | 9 - 38.100  | 19.90 | 20.00 |           |
| 1 3/4 "           | x | 5.080             | TMSC 20199-N- 5" UN  | 6 | 104                  | 7 - 35.560  | 19.90 | 20.00 |           |
| 2 "               | x | 5.644             | TMSC 20199-N-4.5" UN | 6 | 104                  | 7 - 39.511  | 19.90 | 20.00 |           |

| UN 60° intérieur Pas Fin |   |                   |                      |   |                      |             |       |       |           |
|--------------------------|---|-------------------|----------------------|---|----------------------|-------------|-------|-------|-----------|
| NORME                    |   | Référence Article | Z                    | L | Nb Filets / Lg coupe | Dc          | D     | Tarif |           |
| 5 / 16 "                 | x | 0.794             | TMSC 06059-N-32 " UN | 5 | 57                   | 18 - 14.287 | 5.90  | 6.0   |           |
| 7 / 16 "                 | x | 0.907             | TMSC 08079-N-28 " UN | 5 | 63                   | 22 - 19.950 | 7.90  | 8.0   |           |
| 1 / 2 "                  | x | 1.270             | TMSC 10099-N-20 " UN | 5 | 72                   | 18 - 22.860 | 9.90  | 10.0  |           |
| 9 / 16 "                 | x | 1.410             | TMSC 10099-N-18 " UN | 5 | 72                   | 17 - 23.980 | 9.90  | 10.0  | Nous      |
| 5 / 8 "                  | x | 1.587             | TMSC 12119-N-16 " UN | 5 | 83                   | 18 - 28.575 | 11.90 | 12.0  |           |
| 5 / 8 "                  | x | 2.116             | TMSC 12119-N-12 " UN | 5 | 83                   | 14 - 29.630 | 11.90 | 12.0  | Consulter |
| 1 "                      | x | 3.175             | TMSC 16159-N- 8 " UN | 6 | 92                   | 12 - 38.100 | 15.90 | 16.0  |           |
| 1 3/8 "                  | x | 4.233             | TMSC 20199-N- 6 " UN | 6 | 104                  | 9 - 38.100  | 19.90 | 20.0  |           |

| UN 60° extérieur Pas Fin |   |                   |                      |   |                      |             |       |       |           |
|--------------------------|---|-------------------|----------------------|---|----------------------|-------------|-------|-------|-----------|
| NORME                    |   | Référence Article | Z                    | L | Nb Filets / Lg coupe | Dc          | D     | Tarif |           |
| N°6                      | x | 0.794             | TMSC 06059-E-32" UN  | 5 | 57                   | 18 - 14.287 | 5.90  | 6.0   |           |
| N°12                     | x | 0.906             | TMSC 08079-E-28" UN  | 5 | 63                   | 22 - 19.950 | 7.90  | 8.0   |           |
| 1 / 4 "                  | x | 1.270             | TMSC 10099-E-20 " UN | 5 | 72                   | 18 - 22.860 | 9.90  | 10.0  |           |
| 5 / 16 "                 | x | 1.410             | TMSC 10099-E-18" UN  | 5 | 72                   | 17 - 23.980 | 9.90  | 10.0  | Nous      |
| 3 / 8 "                  | x | 1.587             | TMSC 12119-E-16" UN  | 5 | 83                   | 18 - 28.575 | 11.90 | 12.0  |           |
| 9 / 16 "                 | x | 2.116             | TMSC 12119-E-12" UN  | 5 | 83                   | 14 - 29.630 | 11.90 | 12.0  | Consulter |
| 1 "                      | x | 3.175             | TMSC 16159-E- 8" UN  | 6 | 92                   | 12 - 38.100 | 15.90 | 16.0  |           |
| 1 3/8 "                  | x | 4.233             | TMSC 20199-E- 6" UN  | 6 | 104                  | 9 - 38.100  | 19.90 | 20.0  |           |

# ■ Fraise à Fileter Carbone monobloc

BSW – BSP – BSPT – NPT – NPTF – PG

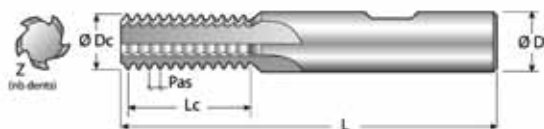

| BSW 55° (British Standard Pipe Whitworth) |                       |   |     |                      |       |       |           |
|---|-----------------------|---|-----|----------------------|-------|-------|-----------|
| NORME                                     | Référence Article     | Z | L   | Nb Filets / Lg coupe | Dc    | D     | Tarif     |
| 3 / 32 " x 0.529                          | TMSC 03015-X-48" BSW  | 3 | 38  | 7 - 3.704            | 1.50  | 3.00  |           |
| 1 / 8 " x 0.635                           | TMSC 03021-X-40" BSW  | 3 | 38  | 7 - 4.445            | 2.10  | 3.00  |           |
| 5 / 32 " x 0.794                          | TMSC 03026-X-32" BSW  | 3 | 38  | 7 - 5.556            | 2.60  | 3.00  |           |
| 1 / 4 " x 1.270                           | TMSC 06040-X-20" BSW  | 3 | 57  | 8 - 10.160           | 4.00  | 3.00  |           |
| 5 / 16 " x 1.411                          | TMSC 06050-X-18" BSW  | 3 | 57  | 8 - 11.288           | 5.00  | 6.00  |           |
| 3 / 8 " x 1.587                           | TMSC 06059-X-16" BSW  | 5 | 57  | 9 - 14.287           | 5.90  | 6.00  |           |
| 7 / 16 " x 1.814                          | TMSC 08079-X-14" BSW  | 5 | 63  | 10 - 18.143          | 7.90  | 8.00  | Nous      |
| 1/2" -9/16 " x 2.116                      | TMSC 08079-X-12" BSW  | 5 | 63  | 9 - 19.050           | 7.90  | 8.00  |           |
| 5 / 8 " x 2.309                           | TMSC 10099-X-11" BSW  | 5 | 72  | 10 - 23.091          | 9.90  | 10.00 | Consulter |
| 3 / 4 " x 2.540                           | TMSC 12119-X-10" BSW  | 5 | 83  | 11 - 27.940          | 11.90 | 12.00 |           |
| 7 / 8 " x 2.822                           | TMSC 12119-X- 9" BSW  | 5 | 83  | 10 - 28.222          | 11.90 | 12.00 |           |
| 1 " x 3.175                               | TMSC 16159-X- 8" BSW  | 6 | 92  | 11 - 34.925          | 15.90 | 16.00 |           |
| 1 1/8" - 1 1/4" x 3.628                   | TMSC 16159-X- 7" BSW  | 6 | 92  | 10 - 36.286          | 15.90 | 16.00 |           |
| 1 3/8" - 1 1/2" x 4.233                   | TMSC 16159-X- 6" BSW  | 6 | 92  | 9 - 38.100           | 15.90 | 16.00 |           |
| 1 3/8" - 1 3/4" x 5.080                   | TMSC 20199-X- 5" BSW  | 6 | 104 | 8 - 40.640           | 19.90 | 20.00 |           |
| 1 1/8" - 2 " x 5.644                      | TMSC 20199-X-4.5" BSW | 6 | 104 | 7 - 39.511           | 19.90 | 20.00 |           |

| BSP 55° (British Standard Pipe Parallel) |                      |   |    |                      |       |       |           |
|--|----------------------|---|----|----------------------|-------|-------|-----------|
| NORME                                    | Référence Article    | Z | L  | Nb Filets / Lg coupe | Dc    | D     | Tarif     |
| 1 / 16 " x 0.907                         | TMSC 06059-X-28" BSP | 5 | 57 | 16 - 14.514          | 5.90  | 6.00  | Nous      |
| 1 / 4 " x 1.337                          | TMSC 08079-X-19" BSP | 5 | 63 | 14 - 18.716          | 7.90  | 8.00  |           |
| 1 / 2 " x 1.814                          | TMSC 12119-X-14" BSP | 5 | 83 | 16 - 29.028          | 11.90 | 12.00 | Consulter |
| 1 " x 2.309                              | TMSC 16159-X-11" BSP | 6 | 92 | 15 - 34.636          | 15.90 | 16.00 |           |

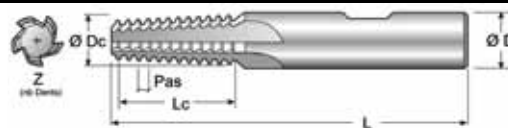

| BSPT 55° Taper 1/16" (British Standard Pipe Tapered) |                       |   |    |                      |       |       |           |
|--|-----------------------|---|----|----------------------|-------|-------|-----------|
| NORME  | Référence Article     | Z | L  | Nb Filets / Lg coupe | Dc    | D     | Tarif     |
| 1 / 16 " x 0.907                                     | TMSC 06059-X-28" BSPT | 5 | 57 | 11 - 9.978           | 5.90  | 6.00  | Nous      |
| 1 / 4 " x 1.337                                      | TMSC 08079-X-19" BSPT | 5 | 63 | 11 - 14.705          | 7.90  | 8.00  |           |
| 1 / 2 " x 1.814                                      | TMSC 12119-X-14" BSPT | 5 | 83 | 11 - 19.957          | 11.90 | 12.00 | Consulter |
| 1 " x 2.309  | TMSC 16159-X-11" BSPT | 6 | 92 | 17 - 39.250          | 15.90 | 16.00 |           |

| NPT 60° (National Pipe Taper) |                        |   |     |                      |       |       |           |
|-------------------------------|------------------------|---|-----|----------------------|-------|-------|-----------|
| NORME                         | Référence Article      | Z | L   | Nb Filets / Lg coupe | Dc    | D     | Tarif     |
| 1 / 16 " x 0.941              | TMSC 06059 -X- 27" NPT | 5 | 57  | 10 - 9.407           | 5.90  | 6.00  |           |
| 1 / 4 " x 1.411               | TMSC 08079 -X- 18" NPT | 5 | 63  | 10 - 14.111          | 7.90  | 8.00  |           |
| 1 / 2 " x 1.814               | TMSC 12119 -X- 14" NPT | 5 | 83  | 11 - 19.957          | 11.90 | 12.00 | Nous      |
| 1 " x 2.209                   | TMSC 16159-X-11.5" NPT | 6 | 92  | 12 - 26.505          | 15.90 | 16.00 |           |
| 2 1/2 " x 3.175               | TMSC 16159 -X- 8" NPT  | 6 | 92  | 10 - 31.750          | 15.90 | 16.00 | Consulter |
| 2 1/2 " x 3.175               | TMSC 20199 -X- 8" NPT  | 6 | 104 | 12 - 38.100          | 19.90 | 20.00 |           |

| NPTF 60° (National Pipe Taper Dryseal) |                         |   |     |                      |       |       |           |
|--|-------------------------|---|-----|----------------------|-------|-------|-----------|
| NORME                                  | Référence Article       | Z | L   | Nb Filets / Lg coupe | Dc    | D     | Tarif     |
| 1 / 16 " x 0.941                       | TMSC 06059 -X- 27" NPTF | 5 | 57  | 10 - 9.407           | 5.90  | 6.00  |           |
| 1 / 4 " x 1.411                        | TMSC 08079 -X- 18" NPTF | 5 | 63  | 10 - 14.111          | 7.90  | 8.00  |           |
| 1 / 2 " x 1.814                        | TMSC 12119 -X- 14" NPTF | 5 | 83  | 11 - 19.957          | 11.90 | 12.00 | Nous      |
| 1 " x 2.209                            | TMSC 16159-X-11.5" NPTF | 6 | 92  | 12 - 26.505          | 15.90 | 16.00 |           |
| 2 1/2 " x 3.175                        | TMSC 16159 -X- 8" NPTF  | 6 | 92  | 10 - 31.750          | 15.90 | 16.00 | Consulter |
| 2 1/2 " x 3.175                        | TMSC 20199 -X- 8" NPTF  | 6 | 104 | 12 - 38.100          | 19.90 | 20.00 |           |

| PG 80°         |                       |   |    |                      |       |       |           |
|----------------|-----------------------|---|----|----------------------|-------|-------|-----------|
| NORME          | Référence Article     | Z | L  | Nb Filets / Lg coupe | Dc    | D     | Tarif     |
| 7              | TMSC 08079 -X- 20" PG | 5 | 63 | 15 - 19.050          | 7.90  | 8.00  | Nous      |
| 9-11-13.5-16   | TMSC 10099 -X- 18" PG | 5 | 72 | 17 - 23.989          | 9.90  | 10.00 |           |
| 21-29-36-42-48 | TMSC 12119 -X- 16" PG | 5 | 83 | 18 - 28.575          | 11.90 | 12.00 | Consulter |

# ■ Fraise à Fileter T2 - T3

## ISO & UN Carbure monobloc

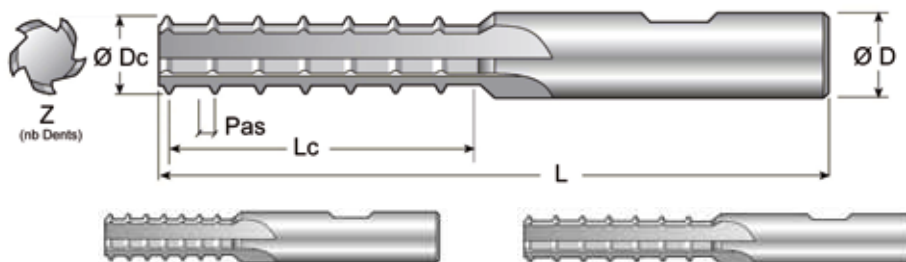

|             |   |       |    |                         | T2 - ISO à 60° |                      |                         | T3 - ISO à 60° |                      |           |  |
|-------------|---|-------|----|-------------------------|----------------|----------------------|-------------------------|----------------|----------------------|-----------|--|
| NORME       | Z | Dc    | D  | Référence Article       | L              | Nb Filets / Lg coupe | Référence Article       | L              | Nb Filets / Lg coupe | Tarif     |  |
| M 4 x 0.70  | 3 | 2.60  | 3  | TMN 03026-N-0.70 ISO-T2 | 38             | 12 - 8.40            | TMN 03026-N-0.70 ISO-T3 | 38             | 18 - 12.60           |           |  |
| M 5 x 0.80  | 3 | 3.60  | 4  | TMN 04036-N-0.80 ISO-T2 | 63             | 14 - 11.20           | TMN 04036-N-0.80 ISO-T3 | 63             | 22 - 17.60           | Nous      |  |
| M 6 x 1.00  | 3 | 4.00  | 6  | TMN 06040-N-1.00 ISO-T2 | 72             | 12 - 12.00           | TMN 06040-N-1.00 ISO-T3 | 63             | 18 - 18.00           |           |  |
| M 8 x 1.25  | 3 | 5.00  | 6  | TMN 06050-N-1.25 ISO-T2 | 72             | 14 - 17.50           | TMN 06050-N-1.25 ISO-T3 | 72             | 21 - 26.25           | Consulter |  |
| M 10 x 1.50 | 5 | 5.90  | 6  | TMN 06059-N-1.50 ISO-T2 | 72             | 14 - 21.00           | TMN 06059-N-1.50 ISO-T3 | 72             | 21 - 31.50           |           |  |
| M 12 x 1.75 | 5 | 7.90  | 8  | TMN 08079-N-1.75 ISO-T2 | 83             | 14 - 24.50           | TMN 08079-N-1.75 ISO-T3 | 83             | 21 - 36.75           |           |  |
| M 14 x 2.00 | 5 | 9.90  | 10 | TMN 10099-N-2.00 ISO-T2 | 83             | 14 - 28.00           | TMN 10099-N-2.00 ISO-T3 | 83             | 21 - 42.00           |           |  |
| M 16 x 2.00 | 5 | 11.90 | 12 | TMN 12119-N-2.00 ISO-T2 | 104            | 16 - 32.00           | TMN 12119-N-2.00 ISO-T3 | 100            | 24 - 48.00           |           |  |
| M 20 x 2.50 | 5 | 11.90 | 12 | TMN 12119-N-2.50 ISO-T2 | 104            | 16 - 40.00           | TMN 12119-N-2.50 ISO-T3 | 100            | 20 - 50.00           |           |  |



|             |   |       |    |                         | T2 - ISO Pas Fin à 60° |                      |                         | T3 - ISO Pas Fin à 60° |                      |           |  |
|-------------|---|-------|----|-------------------------|------------------------|----------------------|-------------------------|------------------------|----------------------|-----------|--|
| NORME       | Z | Dc    | D  | Référence Article       | L                      | Nb Filets / Lg coupe | Référence Article       | L                      | Nb Filets / Lg coupe | Tarif     |  |
| M 8 x 0.75  | 5 | 5.90  | 6  | TMN 06059-N-0.75 ISO-T2 | 72                     | 26 - 19.50           | TMN 06059-N-0.75 ISO-T3 | 72                     | 39 - 29.25           |           |  |
| M 12 x 1.00 | 5 | 7.90  | 8  | TMN 08079-N-1.00 ISO-T2 | 83                     | 24 - 24.00           | TMN 08079-N-1.00 ISO-T3 | 83                     | 36 - 36.00           | Nous      |  |
| M 14 x 1.50 | 5 | 9.90  | 10 | TMN 10099-N-1.50 ISO-T2 | 83                     | 22 - 33.00           | TMN 10099-N-1.50 ISO-T3 | 83                     | 28 - 42.00           |           |  |
| M 16 x 1.00 | 5 | 11.90 | 12 | TMN 12119-N-1.00 ISO-T2 | 100                    | 46 - 46.00           | TMN 12119-N-1.00 ISO-T3 | 104                    | 51 - 51.00           | Consulter |  |
| M 16 x 2.00 | 5 | 11.90 | 12 | TMN 12119-N-2.00 ISO-T2 | 100                    | 22 - 44.00           | TMN 12119-N-2.00 ISO-T3 | 100                    | 24 - 48.00           |           |  |
| M 18 x 1.50 | 5 | 11.90 | 12 | TMN 12119-N-1.50 ISO-T2 | 100                    | 30 - 45.00           | TMN 12119-N-1.50 ISO-T3 | 100                    | 33 - 49.50           |           |  |



|               |   |       |    |                          | T2 - UN à 60° |                      |                            | T3 - UN à 60° |                      |           |  |
|---------------|---|-------|----|--------------------------|---------------|----------------------|----------------------------|---------------|----------------------|-----------|--|
| NORME         | Z | Dc    | D  | Référence Article        | L             | Nb Filets / Lg coupe | Référence Article          | L             | Nb Filets / Lg coupe | Tarif     |  |
| N°4 x 0.635   | 3 | 2.10  | 3  | TMSC 03021-N- 40 " UN T2 | 38            | 10 - 6.350           | TMSC 03021-N- 40 " UN T3   | 38            | 15 - 9.525           |           |  |
| N°8 x 0.705   | 3 | 3.00  | 4  | TMSC 04030-N- 36 " UN T2 | 65            | 12 - 8.466           | TMSC 04030-N- 36 " UN T3   | 65            | 18 - 12.700          |           |  |
| N°8 x 0.794   | 3 | 3.00  | 4  | TMSC 04030-N- 32 " UN T2 | 65            | 12 - 9.525           | TMSC 04030-N- 32 " UN T3   | 65            | 18 - 14.287          |           |  |
| 1/4 " x 1.270 | 3 | 4.00  | 6  | TMSC 06040-N- 20 " UN T2 | 75            | 10 - 12.700          | TMSC 06040-N- 20 " UN T3   | 75            | 15 - 19.050          |           |  |
| 5/16" x 1.411 | 3 | 5.00  | 6  | TMSC 06050-N- 18 " UN T2 | 75            | 12 - 16.933          | TMSC 06050-N- 18 " UN T3   | 75            | 18 - 25.400          |           |  |
| 3/8 " x 1.587 | 5 | 5.90  | 6  | TMSC 06059-N- 16 " UN T2 | 75            | 12 - 19.050          | TMSC 06059-N- 16 " UN T3   | 75            | 18 - 28.575          | Nous      |  |
| 7/16" x 1.814 | 5 | 7.90  | 8  | TMSC 08079-N- 14 " UN T2 | 85            | 14 - 25.400          | TMSC 08079-N- 14 " UN T3   | 85            | 21 - 38.100          |           |  |
| 1/2 " x 1.954 | 5 | 7.90  | 8  | TMSC 08079-N- 13 " UN T2 | 85            | 14 - 27.354          | TMSC 08079-N- 13 " UN T3   | 85            | 21 - 41.031          | Consulter |  |
| 9/16" x 2.116 | 5 | 9.90  | 10 | TMSC 10099-N- 12 " UN T2 | 85            | 14 - 29.633          | TMSC 10099-N- 12 " UN T3   | 85            | 21 - 44.450          |           |  |
| 5/8 " x 2.309 | 5 | 11.90 | 12 | TMSC 10099-N- 11 " UN T2 | 100           | 14 - 32.327          | TMSC 10099-N- 11 " UN T3   | 100           | 19 - 43.872          |           |  |
| 3/4 " x 2.540 | 5 | 11.90 | 12 | TMSC 12119-N- 10 " UN T2 | 100           | 16 - 40.640          | TMSC 12119-N- 10 " UN T3 * | 100           | 20 - 50.800          |           |  |
| 7/8 " x 2.822 | 6 | 15.90 | 16 | TMSC 12119-N- 9 " UN T2  | 104           | 16 - 45.156          | -                          | -             | -                    |           |  |
| 1 " x 3.175   | 6 | 15.90 | 16 | TMSC 16159-N- 8 " UN T2  | 104           | 16 - 50.800          | -                          | -             | -                    |           |  |

## ■ Fraise à Fileter

Carbure monobloc à Alésage

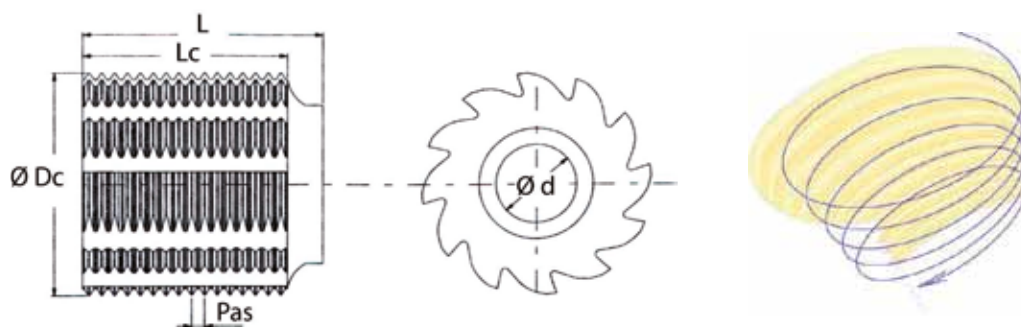

### ISO & UN 60° - Ø 35

| NORME          | Référence Article   | Z  | L  | Nb Filets / Lg coupe | Dc | D  | Tarif     |
|----------------|---------------------|----|----|----------------------|----|----|-----------|
| M 48 x 1.50    | TMSC 350-N-1.50 ISO | 12 | 38 | 20 - 30.0            | 35 | 13 |           |
| M 48 x 2.00    | TMSC 350-N-2.00 ISO | 12 | 38 | 15 - 30.0            | 35 | 13 |           |
| M 48 x 3.00    | TMSC 350-N-3.00 ISO | 12 | 38 | 10 - 30.0            | 35 | 13 |           |
| M 48 x 4.00    | TMSC 350-N-4.00 ISO | 12 | 38 | 7 - 28.0             | 35 | 13 | Nous      |
| 1 3/4" x 1.269 | TMSC 350- N -20" UN | 12 | 38 | 23 - 29.2            | 35 | 13 | Consulter |
| 1 3/4" x 1.409 | TMSC 350- N -18" UN | 12 | 38 | 21 - 29.6            | 35 | 13 |           |
| 1 3/4" x 1.589 | TMSC 350- N -16" UN | 12 | 38 | 18 - 28.6            | 35 | 13 |           |
| 1 3/4" x 2.114 | TMSC 350- N -12" UN | 12 | 38 | 14 - 29.6            | 35 | 13 |           |
| 1 3/4" x 3.177 | TMSC 350- N - 8" UN | 12 | 38 | 9 - 28.6             | 35 | 13 |           |
| 1 3/4" x 4.228 | TMSC 350- N - 6" UN | 12 | 38 | 7 - 29.6             | 35 | 13 |           |

### ISO & UN 60° - Ø 45

| NORME          | Référence Article    | Z  | L  | Nb Filets / Lg coupe | Dc | D  | Tarif     |
|----------------|----------------------|----|----|----------------------|----|----|-----------|
| M 56 x 1.50    | TMSC 450-N-1.50 ISO  | 12 | 47 | 29 - 39.0            | 45 | 16 |           |
| M 56 x 2.00    | TMSC 450-N-2.00 ISO  | 12 | 47 | 20 - 40.0            | 45 | 16 |           |
| M 56 x 3.00    | TMSC 450-N-3.00 ISO  | 12 | 47 | 13 - 39.0            | 45 | 16 |           |
| M 56 x 4.00    | TMSC 450-N-4.00 ISO  | 12 | 47 | 10 - 40.0            | 45 | 16 |           |
| M 56 x 5.50    | TMSC 450-N-5.50 ISO  | 12 | 47 | 7 - 38.5             | 45 | 16 |           |
| M 64 x 6.00    | TMSC 450-N-6.00 ISO  | 12 | 47 | 6 - 36.0             | 45 | 16 | Nous      |
| 2 1/2" x 1.271 | TMSC 450- N -20" UN  | 12 | 47 | 31 - 39.4            | 45 | 16 | Consulter |
| 2 1/2" x 1.588 | TMSC 450- N -16" UN  | 12 | 47 | 25 - 39.7            | 45 | 16 |           |
| 2 1/2" x 2.116 | TMSC 450- N - 12" UN | 12 | 47 | 18 - 38.1            | 45 | 16 |           |
| 2 1/2" x 3.175 | TMSC 450- N - 8" UN  | 12 | 47 | 12 - 38.1            | 45 | 16 |           |
| 2 1/2" x 4.233 | TMSC 450- N - 6" UN  | 12 | 47 | 9 - 38.1             | 45 | 16 |           |
| 2 1/4" x 5.643 | TMSC 450- N -4.5" UN | 12 | 47 | 7 - 39.5             | 45 | 16 |           |
| 2 1/2" x 6.350 | TMSC 450- N - 4" UN  | 12 | 47 | 6 - 38.1             | 45 | 16 |           |

### ISO & UN 60° - Ø 55

| NORME          | Référence Article   | Z  | L  | Nb Filets / Lg coupe | Dc | D  | Tarif     |
|----------------|---------------------|----|----|----------------------|----|----|-----------|
| M 64 x 1.50    | TMSC 550-N-1.50 ISO | 12 | 58 | 33 - 49.5            | 55 | 22 |           |
| M 64 x 2.00    | TMSC 550-N-2.00 ISO | 12 | 58 | 25 - 50.0            | 55 | 22 |           |
| M 64 x 3.00    | TMSC 550-N-3.00 ISO | 12 | 58 | 16 - 48.0            | 55 | 22 |           |
| M 64 x 4.00    | TMSC 550-N-4.00 ISO | 12 | 58 | 12 - 48.0            | 55 | 22 | Nous      |
| M 64 x 6.00    | TMSC 550-N-6.00 ISO | 12 | 58 | 8 - 48.0             | 55 | 22 |           |
| 2 3/4" x 1.269 | TMSC 550- N -20" UN | 12 | 58 | 39 - 49.5            | 55 | 22 | Consulter |
| 2 3/4" x 1.587 | TMSC 550- N -16" UN | 12 | 58 | 31 - 49.2            | 55 | 22 |           |
| 2 3/4" x 2.117 | TMSC 550- N -12" UN | 12 | 58 | 23 - 48.7            | 55 | 22 |           |
| 2 3/4" x 3.173 | TMSC 550- N - 8" UN | 12 | 58 | 15 - 47.6            | 55 | 22 |           |
| 2 3/4" x 4.236 | TMSC 550- N - 6" UN | 12 | 58 | 11 - 46.6            | 55 | 22 |           |
| 2 3/4" x 6.357 | TMSC 550- N - 4" UN | 12 | 58 | 7 - 44.5             | 55 | 22 |           |

# ■ Plaquette carbure indexable

Pour Fraise à Fileter ISO & UN 60°

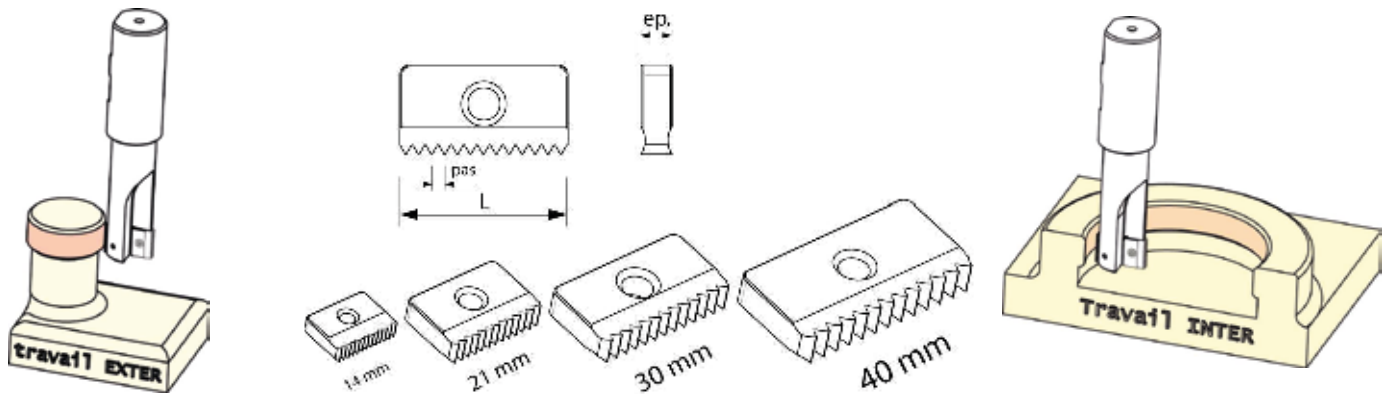

| Travail EXTERIEUR |  |
|-------------------|--|
| Référence Article |  |
| 14-ETM-1.00 ISO   |  |
| 21-ETM-1.00 ISO   |  |
| 14-ETM-1.50 ISO   |  |
| 21-ETM-1.50 ISO   |  |
| 30-ETM-1.50 ISO   |  |
| 14-ETM-2.00 ISO   |  |
| 21-ETM-2.00 ISO   |  |
| 30-ETM-2.00 ISO   |  |
| 21-ETM-2.50 ISO   |  |
| 30-ETM-2.50 ISO   |  |
| 21-ETM-3.00 ISO   |  |
| 30-ETM-3.00 ISO   |  |
| 21-ETM-3.50 ISO   |  |
| 30-ETM-3.50 ISO   |  |
| 30-ETM-4.00 ISO   |  |
| 40-ETM-4.00 ISO   |  |
| 40-ETM-5.00 ISO   |  |
| 40-ETM-6.00 ISO   |  |

| Pass | L  | Nb Filets | Centrage | Porte-Outil | Tarif     |
|------|----|-----------|----------|-------------|-----------|
| 1.00 | 14 | 14        | 0        | TMH.....-14 |           |
| 1.00 | 21 | 21        | 0        | TMH.....-21 |           |
| 1.50 | 14 | 9         | 0.25     | TMH.....-14 |           |
| 1.50 | 21 | 14        | 0        | TMH.....-21 |           |
| 1.50 | 30 | 20        | 0        | TMH.....-30 |           |
| 2.00 | 14 | 7         | 0        | TMH.....-14 | Nous      |
| 2.00 | 21 | 10        | 0.50     | TMH.....-21 |           |
| 2.00 | 30 | 15        | 0        | TMH.....-30 | Consulter |
| 2.50 | 21 | 8         | 0.5      | TMH.....-21 |           |
| 2.50 | 30 | 12        | 0        | TMH.....-30 |           |
| 3.00 | 21 | 7         | 0        | TMH.....-21 |           |
| 3.00 | 30 | 10        | 0        | TMH.....-30 |           |
| 3.50 | 21 | 6         | 0        | TMH.....-21 |           |
| 3.50 | 30 | 8         | 1        | TMH.....-30 |           |
| 4.00 | 30 | 7         | 1        | TMH.....-30 |           |
| 4.00 | 40 | 10        | 0        | TMH.....-40 |           |
| 5.00 | 40 | 8         | 0        | TMH.....-40 |           |
| 6.00 | 40 | 6         | 2        | TMH.....-40 |           |

| Travail Intérieur |  |
|-------------------|--|
| Référence Article |  |
| 14-NTM-1.00 ISO   |  |
| 21-NTM-1.00 ISO   |  |
| 14-NTM-1.50 ISO   |  |
| 21-NTM-1.50 ISO   |  |
| 30-NTM-1.50 ISO   |  |
| 14-NTM-2.00 ISO   |  |
| 21-NTM-2.00 ISO   |  |
| 30-NTM-2.00 ISO   |  |
| 21-NTM-2.50 ISO   |  |
| 30-NTM-2.50 ISO   |  |
| 21-NTM-3.00 ISO   |  |
| 30-NTM-3.00 ISO   |  |
| 21-NTM-3.50 ISO   |  |
| 30-NTM-3.50 ISO   |  |
| 30-NTM-4.00 ISO   |  |
| 40-NTM-4.00 ISO   |  |
| 40-NTM-5.00 ISO   |  |
| 40-NTM-6.00 ISO   |  |

| Travail Extérieur |  |
|-------------------|--|
| Référence Article |  |
| 14-ETM-48"UN      |  |
| 14-ETM-40"UN      |  |
| 14-ETM-32"UN      |  |
| 14-ETM-28"UN      |  |
| 14-ETM-27"UN      |  |
| 14-ETM-24"UN      |  |
| 14-ETM-20"UN      |  |
| 21-ETM-20"UN      |  |
| 14-ETM-18"UN      |  |
| 21-ETM-18"UN      |  |
| 30-ETM-18"UN      |  |
| 40-ETM-18"UN      |  |
| 14-ETM-16"UN      |  |
| 21-ETM-16"UN      |  |
| 30-ETM-16"UN      |  |
| 40-ETM-16"UN      |  |
| 14-ETM-14"UN      |  |
| 21-ETM-14"UN      |  |
| 30-ETM-14"UN      |  |
| 40-ETM-14"UN      |  |
| 14-ETM-12"UN      |  |
| 21-ETM-12"UN      |  |
| 30-ETM-12"UN      |  |
| 40-ETM-12"UN      |  |
| 21-ETM-10"UN      |  |
| 30-ETM-10"UN      |  |
| 40-ETM-10"UN      |  |
| 21-ETM-9"UN       |  |
| 30-ETM-9"UN       |  |
| 40-ETM-9"UN       |  |
| 21-ETM-8"UN       |  |
| 30-ETM-8"UN       |  |
| 40-ETM-8"UN       |  |
| 30-ETM-7"UN       |  |
| 40-ETM-7"UN       |  |
| 30-ETM-6"UN       |  |
| 40-ETM-6"UN       |  |
| 30-ETM-5"UN       |  |
| 40-ETM-5"UN       |  |
| 40-ETM-4.5"UN     |  |
| 40-ETM-4"UN       |  |
| 40-ETM-3.5"UN     |  |

| Pass | L  | Nb Filets | Centrage | Porte-Outil | Tarif     |
|------|----|-----------|----------|-------------|-----------|
| 48"  | 14 | 26        | 0.121    | TMH.....-14 |           |
| 40"  | 14 | 22        | 0.015    | TMH.....-14 |           |
| 32"  | 14 | 17        | 0.253    | TMH.....-14 |           |
| 28"  | 14 | 15        | 0.196    | TMH.....-14 |           |
| 27"  | 14 | 14        | 0.415    | TMH.....-14 |           |
| 24"  | 14 | 13        | 0.121    | TMH.....-14 | Nous      |
| 20"  | 14 | 11        | 0.015    | TMH.....-14 |           |
| 20"  | 21 | 16        | 0.340    | TMH.....-21 | Consulter |
| 18"  | 14 | 11        | 0.650    | TMH.....-14 |           |
| 18"  | 21 | 14        | 0.622    | TMH.....-21 |           |
| 18"  | 30 | 21        | 0.183    | TMH.....-30 |           |
| 18"  | 40 | 28        | 0.244    | TMH.....-40 |           |
| 16"  | 14 | 8         | 0.650    | TMH.....-14 |           |
| 16"  | 21 | 13        | 0.181    | TMH.....-21 | Nous      |
| 16"  | 30 | 18        | 0.712    | TMH.....-30 |           |
| 16"  | 40 | 25        | 0.156    | TMH.....-40 | Consulter |
| 14"  | 14 | 8         | -0.257   | TMH.....-14 |           |
| 14"  | 21 | 11        | 0.521    | TMH.....-21 |           |
| 14"  | 30 | 16        | 0.486    | TMH.....-30 |           |
| 14"  | 40 | 22        | 0.043    | TMH.....-40 |           |
| 12"  | 14 | 6         | 0.650    | TMH.....-14 |           |
| 12"  | 21 | 9         | 0.975    | TMH.....-21 |           |
| 12"  | 30 | 14        | 0.183    | TMH.....-30 |           |
| 12"  | 40 | 18        | 0.950    | TMH.....-40 | Nous      |
| 10"  | 21 | 8         | 0.340    | TMH.....-21 |           |
| 10"  | 30 | 11        | 1.030    | TMH.....-30 | Consulter |
| 10"  | 40 | 14        | 0.950    | TMH.....-40 |           |
| 9"   | 21 | 7         | 0.622    | TMH.....-21 |           |
| 9"   | 30 | 10        | 0.889    | TMH.....-30 |           |
| 9"   | 40 | 14        | 0.244    | TMH.....-40 |           |
| 8"   | 21 | 6         | 0.975    | TMH.....-21 |           |
| 8"   | 30 | 9         | 0.713    | TMH.....-30 |           |
| 8"   | 40 | 12        | 0.950    | TMH.....-40 |           |
| 7"   | 30 | 8         | 0.486    | TMH.....-30 |           |
| 7"   | 40 | 11        | 0.043    | TMH.....-40 |           |
| 6"   | 30 | 7         | 0.183    | TMH.....-30 | Nous      |
| 6"   | 40 | 9         | 0.950    | TMH.....-40 |           |
| 5"   | 30 | 6         | -0.240   | TMH.....-30 | Consulter |
| 5"   | 40 | 8         | -0.320   | TMH.....-40 |           |
| 4.5" | 40 | 7         | 0.244    | TMH.....-40 |           |
| 4"   | 40 | 6         | 0.950    | TMH.....-40 |           |
| 3.5" | 40 | 5         | 1.857    | TMH.....-40 |           |

| Travail Intérieur |  |
|-------------------|--|
| Référence Article |  |
| 14-NTM-48"UN      |  |
| 14-NTM-40"UN      |  |
| 14-NTM-32"UN      |  |
| 14-NTM-28"UN      |  |
| 14-NTM-27"UN      |  |
| 14-NTM-24"UN      |  |
| 14-NTM-20"UN      |  |
| 21-NTM-20"UN      |  |
| 14-NTM-18"UN      |  |
| 21-NTM-18"UN      |  |
| 30-NTM-18"UN      |  |
| 40-NTM-18"UN      |  |
| 14-NTM-16"UN      |  |
| 21-NTM-16"UN      |  |
| 30-NTM-16"UN      |  |
| 40-NTM-16"UN      |  |
| 14-NTM-14"UN      |  |
| 21-NTM-14"UN      |  |
| 30-NTM-14"UN      |  |
| 40-NTM-14"UN      |  |
| 14-NTM-12"UN      |  |
| 21-NTM-12"UN      |  |
| 30-NTM-12"UN      |  |
| 40-NTM-12"UN      |  |
| 21-NTM-10"UN      |  |
| 30-NTM-10"UN      |  |
| 40-NTM-10"UN      |  |
| 21-NTM-9"UN       |  |
| 30-NTM-9"UN       |  |
| 40-NTM-9"UN       |  |
| 21-NTM-8"UN       |  |
| 30-NTM-8"UN       |  |
| 40-NTM-8"UN       |  |
| 30-NTM-7"UN       |  |
| 40-NTM-7"UN       |  |
| 30-NTM-6"UN       |  |
| 40-NTM-6"UN       |  |
| 30-NTM-5"UN       |  |
| 40-NTM-5"UN       |  |
| 40-NTM-4.5"UN     |  |
| 40-NTM-4"UN       |  |
| 40-NTM-3.5"UN     |  |

# ■ Plaque carbure indexable pour Filetage

BSP – NPSM – NPSF – BSPT – NPT – NPTF

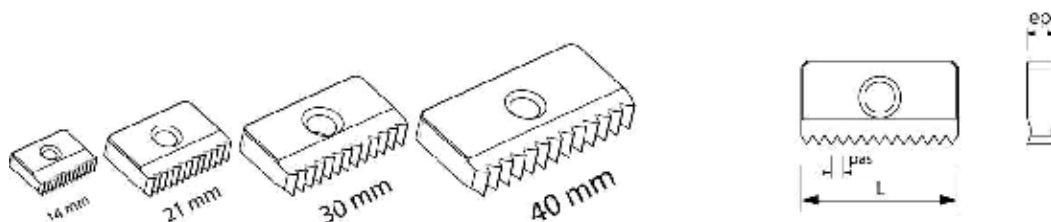

## BSP à 55°

| Pas | Référence Article | L  | Nb Filets | Centrage | Porte-Outil   | Tarif     |
|-----|-------------------|----|-----------|----------|---------------|-----------|
| 19" | 14-XTM-19" BSP    | 14 | 10        | 0.316    | TMH. .... -14 |           |
| 14" | 14-XTM-14" BSP    | 14 | 7         | 0.650    | TMH. .... -14 | Nous      |
| 14" | 21-XTM-14" BSP    | 21 | 11        | 0.521    | TMH. .... -21 |           |
| 14" | 30-XTM-14" BSP    | 30 | 16        | 0.486    | TMH. .... -30 | Consulter |
| 11" | 21-XTM-11" BSP    | 21 | 9         | 0.109    | TMH. .... -21 |           |
| 11" | 30-XTM-11" BSP    | 30 | 13        | 0.009    | TMH. .... -30 |           |
| 11" | 40-XTM-11" BSP    | 40 | 17        | 0.373    | TMH. .... -40 |           |



## NPSM à 60°

| Pas   | Référence Article | L  | Nb Filets | Centrage | Porte-Outil   | Tarif     |
|-------|-------------------|----|-----------|----------|---------------|-----------|
| 18"   | 14-XTM-18" NPSM   | 14 | 9         | 0.650    | TMH. .... -14 |           |
| 14"   | 14-XTM-14" NPSM   | 14 | 7         | 0.650    | TMH. .... -14 | Nous      |
| 14"   | 21-XTM-14" NPSM   | 21 | 11        | 0.521    | TMH. .... -21 |           |
| 11.5" | 21-XTM-11.5" NPSM | 21 | 9         | 0.561    | TMH. .... -21 | Consulter |
| 11.5" | 30-XTM-11.5" NPSM | 30 | 13        | 0.643    | TMH. .... -30 |           |
| 8"    | 30-XTM-8" NPSM    | 30 | 9         | 0.712    | TMH. .... -30 |           |



## NPSF à 60°

| Pas   | Référence Article | L  | Nb Filets | Centrage | Porte-Outil   | Tarif     |
|-------|-------------------|----|-----------|----------|---------------|-----------|
| 18"   | 14-XTM-18" NPSF   | 14 | 9         | 0.650    | TMH. .... -14 |           |
| 14"   | 14-XTM-14" NPSF   | 14 | 7         | 0.650    | TMH. .... -14 | Nous      |
| 14"   | 21-XTM-14" NPSF   | 21 | 11        | 0.521    | TMH. .... -21 |           |
| 11.5" | 21-XTM-11.5" NPSF | 21 | 9         | 0.561    | TMH. .... -21 | Consulter |
| 11.5" | 30-XTM-11.5" NPSF | 30 | 13        | 0.643    | TMH. .... -30 |           |
| 8"    | 30-XTM-8" NPSF    | 30 | 9         | 0.712    | TMH. .... -30 |           |



## BSPT à 55° Taper 1 :16

| Pas | Référence Article | L  | Nb Filets | Centrage | Porte-Outil   | Tarif     |
|-----|-------------------|----|-----------|----------|---------------|-----------|
| 19" | 14-XTM-19" BSPT-S | 14 | 10        | 0.316    | TMH. .... -14 |           |
| 14" | 14-XTM-14" BSPT-S | 14 | 7         | 0.650    | TMH. .... -14 |           |
| 14" | 21-XTM-14" BSPT-S | 21 | 11        | 0.521    | TMH. .... -21 |           |
| 14" | 30-XTM-14" BSPT-S | 30 | 16        | 0.486    | TMH. .... -30 | Nous      |
| 11" | 21-XTM-11" BSPT-S | 21 | 9         | 0.109    | TMH. .... -21 |           |
| 11" | 30-XTM-11" BSPT-S | 30 | 13        | 0.009    | TMH. .... -30 | Consulter |
| 11" | 40-XTM-11" BSPT-S | 40 | 17        | 0.373    | TMH. .... -40 |           |



## NPT à 60° Taper 1 :16

| Pas   | Référence Article    | L  | Nb Filets | Centrage | Porte-Outil     | Tarif     |
|-------|----------------------|----|-----------|----------|-----------------|-----------|
| 18"   | 14-XTM-18" NPT-SXP   | 14 | 9         | 0.650    | TMH. .... -14 T |           |
| 18"   | 21-XTM-18" NPT-SXP   | 21 | 14        | 0.622    | TMH. .... -21 T |           |
| 14"   | 14-XTM-14" NPT-SXP   | 14 | 7         | 0.650    | TMH. .... -14 T |           |
| 14"   | 21-XTM-14" NPT-SXP   | 21 | 11        | 0.521    | TMH. .... -21 T | Nous      |
| 11.5" | 21-XTM-11.5" NPT-SXP | 21 | 9         | 0.561    | TMH. .... -21   |           |
| 11.5" | 30-XTM-11.5" NPT-SXP | 30 | 13        | 0.643    | TMH. .... -30   | Consulter |
| 11.5" | 40-XTM-11.5" NPT-SXP | 40 | 18        | 0.122    | TMH. .... -40   |           |
| 8"    | 30-XTM-8" NPT-SXP    | 30 | 9         | 0.712    | TMH. .... -30   |           |
| 8"    | 40-XTM-8" NPT-SXP    | 40 | 12        | 0.950    | TMH. .... -40   |           |



## NPTF à 60° Taper 1 :16

| Pas   | Référence Article     | L  | Nb Filets | Centrage | Porte-Outil     | Tarif     |
|-------|-----------------------|----|-----------|----------|-----------------|-----------|
| 18"   | 14-XTM-18" NPTF-SXP   | 14 | 9         | 0.650    | TMH. .... -14 T |           |
| 18"   | 21-XTM-18" NPTF-SXP   | 21 | 14        | 0.622    | TMH. .... -21 T |           |
| 14"   | 14-XTM-14" NPTF-SXP   | 14 | 7         | 0.650    | TMH. .... -14 T |           |
| 14"   | 21-XTM-14" NPTF-SXP   | 21 | 11        | 0.521    | TMH. .... -21 T | Nous      |
| 11.5" | 21-XTM-11.5" NPTF-SXP | 21 | 9         | 0.561    | TMH. .... -21   |           |
| 11.5" | 30-XTM-11.5" NPTF-SXP | 30 | 13        | 0.643    | TMH. .... -30   | Consulter |
| 11.5" | 40-XTM-11.5" NPTF-SXP | 40 | 18        | 0.122    | TMH. .... -40   |           |
| 8"    | 30-XTM-8" NPTF-SXP    | 30 | 9         | 0.712    | TMH. .... -30   |           |
| 8"    | 40-XTM-8" NPTF-SXP    | 40 | 12        | 0.950    | TMH. .... -40   |           |



## Fraise à fileter QC

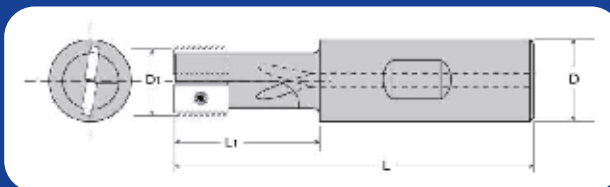

| Plaquette | Référence Article | Z | L   | L1 | D  | Dc | Tarif     |
|-----------|-------------------|---|-----|----|----|----|-----------|
| TM 14     | TMH02012-1-14     | 1 | 75  | 20 | 20 | 12 |           |
| TM 14     | TMH02017-1-14     | 1 | 85  | 30 | 20 | 17 |           |
| TM 21     | TMH02020-1-21     | 1 | 93  | 40 | 20 | 20 |           |
| TM 30     | TMH02529-1-30     | 1 | 108 | 5  | 25 | 29 | Nous      |
| TM 30     | TMH03238-1-30     | 1 | 130 | 70 | 32 | 38 |           |
| TM 40     | TMH04044-1-40     | 1 | 153 | 82 | 40 | 44 | Consulter |
| TM 14     | TMH02020-2-14     | 2 | 93  | 40 | 20 | 20 |           |
| TM 21     | TMH02530-2-21     | 2 | 108 | 50 | 25 | 30 |           |
| TM 30     | TMH03240-2-30     | 2 | 130 | 70 | 32 | 40 |           |
| TM 40     | TMH04050-2-40     | 2 | 153 | 82 | 40 | 50 |           |

## Fraise à fileter à Alésage

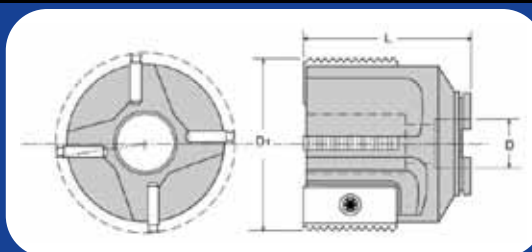

| Plaquette | Référence Article | Z | L  | L1 | D  | Dc  | Tarif     |
|-----------|-------------------|---|----|----|----|-----|-----------|
| TM 30     | TMH06322-4-30     | 4 | 50 | 30 | 22 | 63  |           |
| TM 30     | TMH08027-4-30     | 4 | 55 | 30 | 27 | 80  | Nous      |
| TM 40     | TMH08027-4-40     | 4 | 65 | 40 | 27 | 80  |           |
| TM 30     | TMH10032-5-30     | 5 | 60 | 30 | 32 | 100 | Consulter |
| TM 40     | TMH10032-5-40     | 5 | 70 | 40 | 32 | 100 |           |

## Accessoires



| Plaquette | Référence Article | Clef Torx | Ref Clef torx | Tarif     | Vis torx  | Ref Vis  | Tarif     |
|-----------|-------------------|-----------|---------------|-----------|-----------|----------|-----------|
| TM 14     | TMH02012-1-14     | n°7       | 263490        |           | M 2.5 x 6 | 60F2506T |           |
| TM 14     | TMH02017-1-14     | n°7       | 263490        |           | M 2.5 x 6 | 60F2506T |           |
| TM 21     | TMH02020-1-21     | n°20      | 263994        |           | M 4 x 10  | 60F4010T |           |
| TM 30     | TMH02529-1-30     | n°20      | 263994        | Nous      | M 5 x 12  | 60F5012T | Nous      |
| TM 30     | TMH03238-1-30     | n°20      | 263994        |           | M 5 x 12  | 60F5012T |           |
| TM 40     | TMH04044-1-40     | n°20      | 263994        | Consulter | M 5 x 12  | 60F5012T | Consulter |
| TM 14     | TMH02020-2-14     | n°7       | 263490        |           | M 2.5 x 6 | 60F2506T |           |
| TM 21     | TMH02530-2-21     | n°20      | 263994        |           | M 4 x 10  | 60F4010T |           |
| TM 30     | TMH03240-2-30     | n°20      | 263994        |           | M 5 x 12  | 60F5012T |           |
| TM 40     | TMH04050-2-40     | n°20      | 263994        |           | M 5 x 12  | 60F5012T |           |
| TM 30     | TMH06322-4-30     | n°20      | 263994        |           | M 5 x 12  | 60F5012T |           |
| TM 30     | TMH08027-4-30     | n°20      | 263994        |           | M 5 x 12  | 60F5012T |           |
| TM 40     | TMH08027-4-40     | n°20      | 263994        |           | M 5 x 12  | 60F5012T |           |
| TM 30     | TMH10032-5-30     | n°20      | 263994        |           | M 5 x 12  | 60F5012T |           |
| TM 40     | TMH10032-5-40     | n°20      | 263994        |           | M 5 x 12  | 60F5012T |           |

# evatec tools®

Solutions sur mesure pour votre usinage  
*Machining solutions especially for you*

## CARBURE



## PCBN / PCD



## AÉRONAUTIQUE



## TOURNAGE



## USINAGE DE TROUS

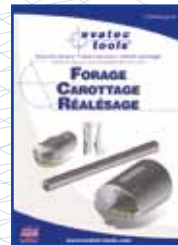

## ATTACHEMENTS

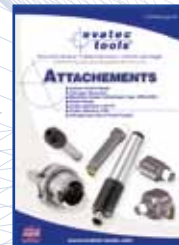

## FRAISAGE

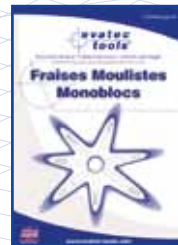

## MÉTIERS / SPÉCIFIQUES

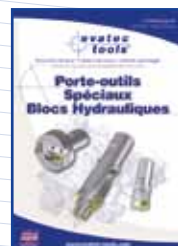

Téléchargez nos catalogues sur [www.evatec-tools.com](http://www.evatec-tools.com)

Download our CATALOGS on [www.evatec-tools.com](http://www.evatec-tools.com)

**evatools® evamet® carbex® gmo®  
coriatec® create outillage®**

12, rue des Terres Rouges - Z.I. Metzange - 57100 Thionville

Tél. : 03 82 88 61 61 - Fax. : 03 82 88 33 19

E-mail : [info@evatec-tools.fr](mailto:info@evatec-tools.fr)

[www.evatec-tools.com](http://www.evatec-tools.com)

