

WEDM tooling

FT 00332 - Version 1012 / English

F a s t t o c u t

F-Tool WEDM tooling system

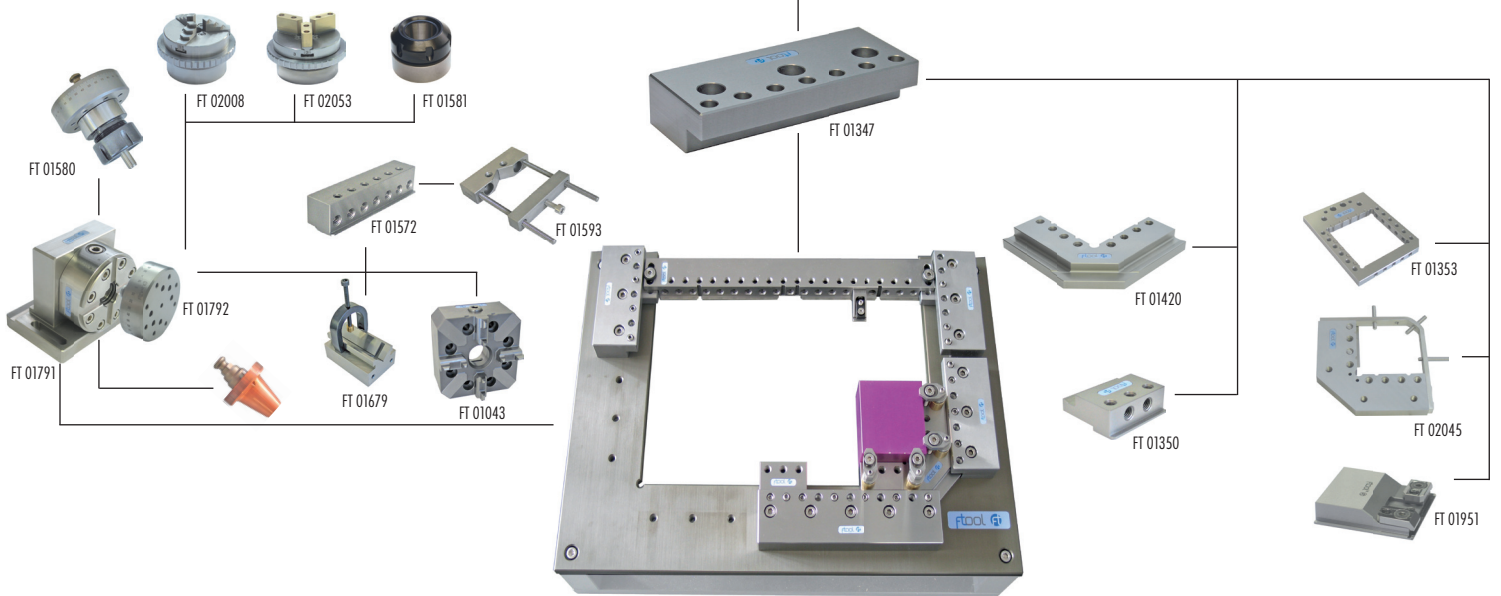
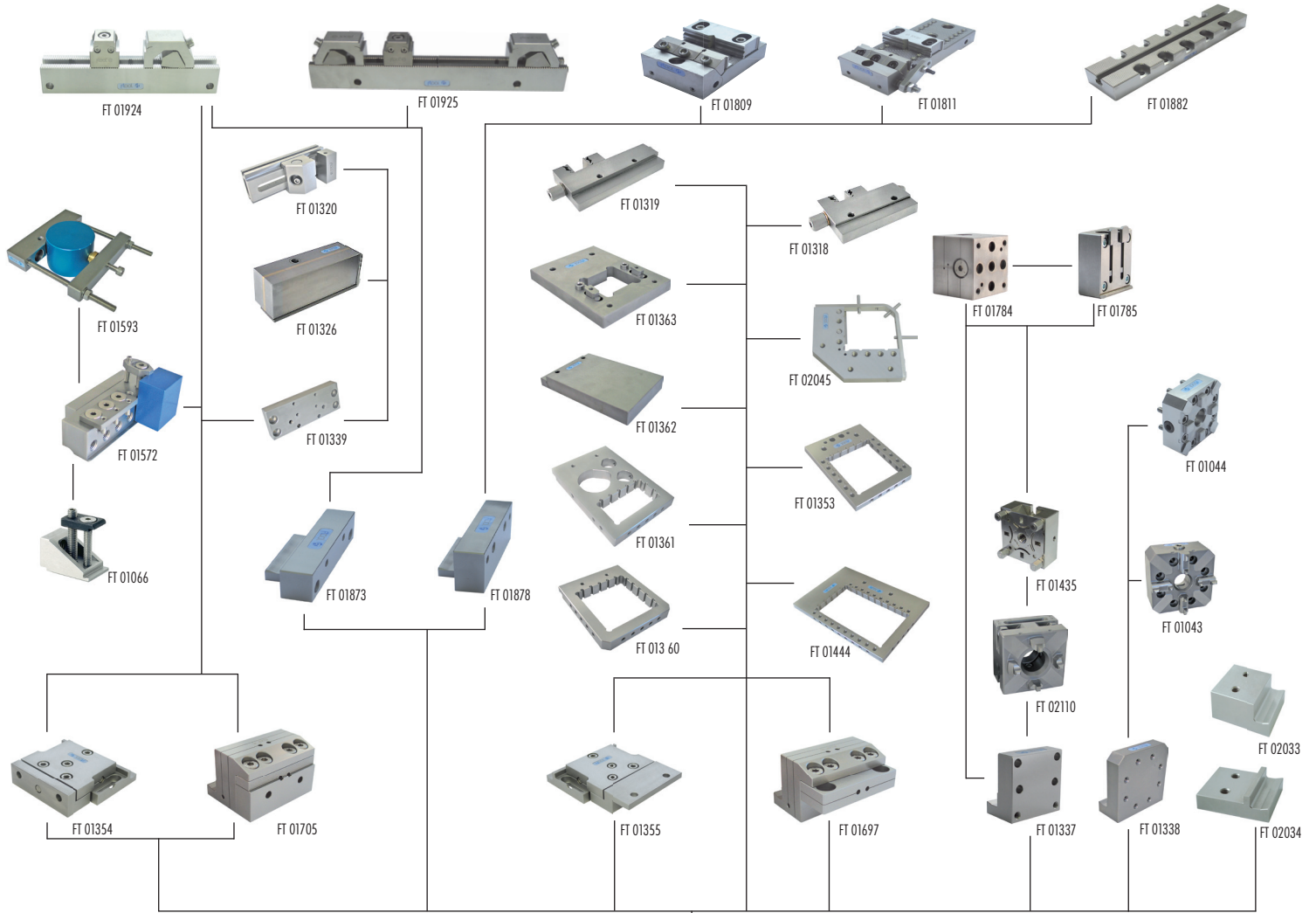

F-Tool Frame Set Link

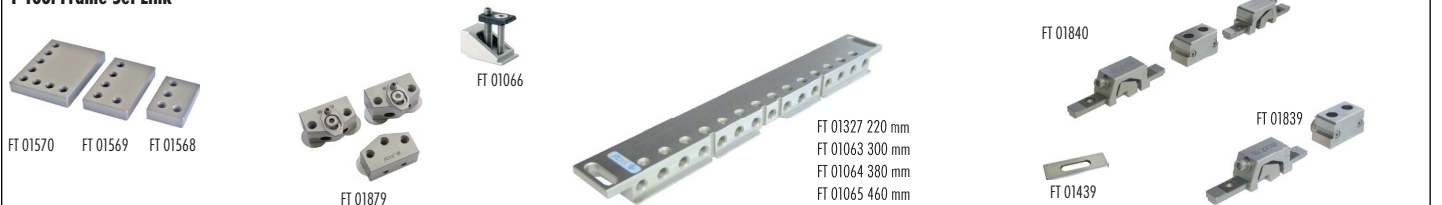

F-Tool WEDM tooling system

Extensive duties - simply resolved!

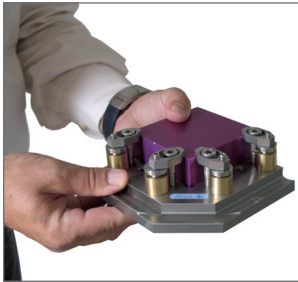

Palletisation of the work pieces

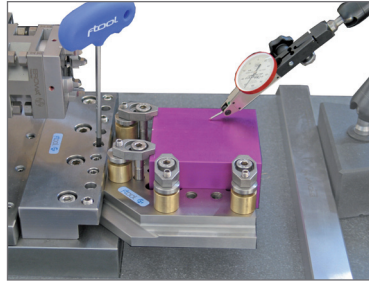

Presetting and control outside the machine

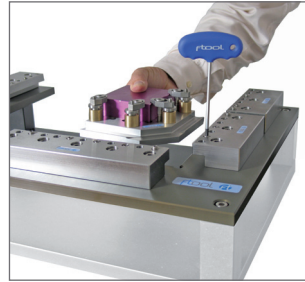

Simple, handy manipulation and transfer into the machine.

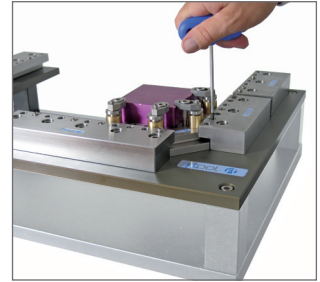

Clamped fast in reference position.

CLAMP



PRESET



PROCESS



Ready for:
EDM DRILLING
WIRE EDM
EDM

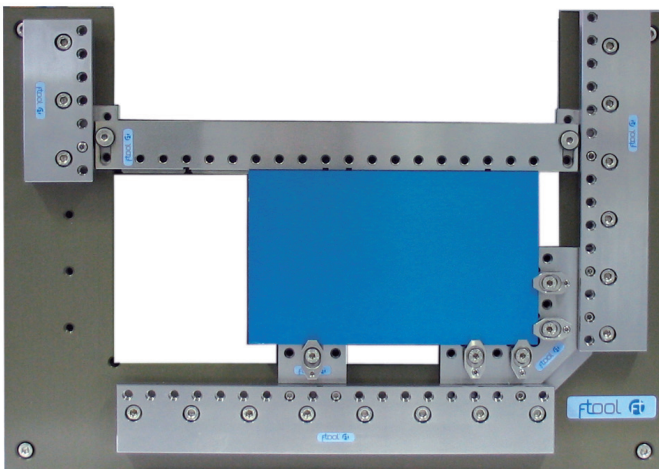

Modular layout in the machine with stoppers fixtures and multifunctional clamping bars.

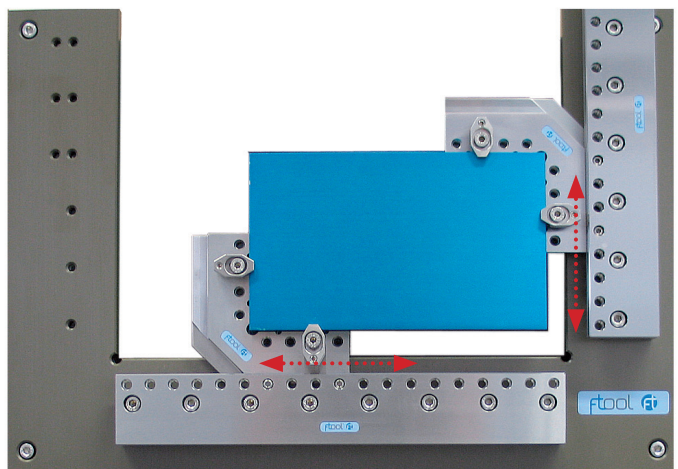

Large and small pieces can be clamped flexibly with an optimal accessibility into the working range of the machine.

A comprehensive, accurate clamping assortment completes the system

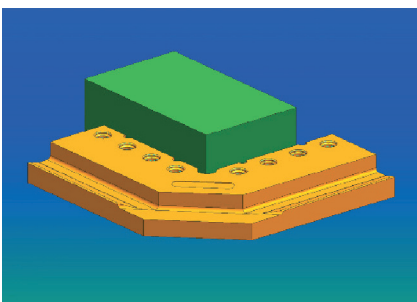

The parts can be palletised outside the machine...

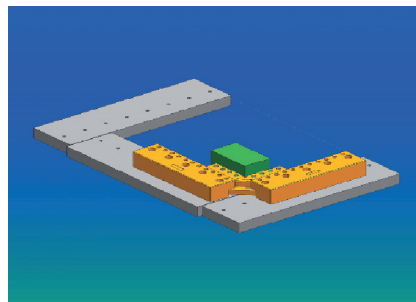

...and be positioned in the machine

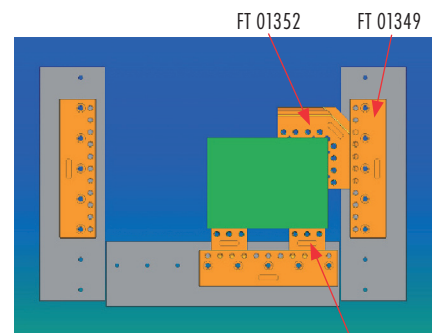

Example of use ruler set 1 (FT 01344) FT 01350

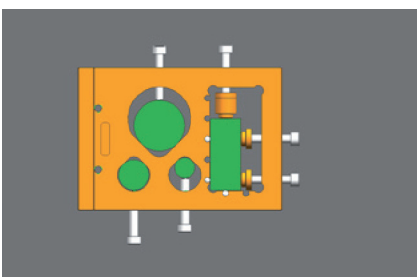

The universal pallet can be charged on a stone plate...

► The zero position is simple and with no effort warranted.

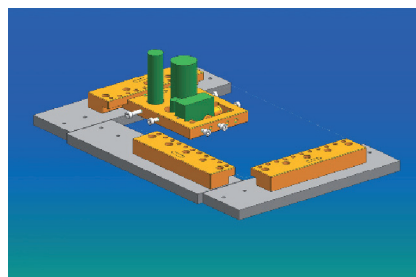

...and in no time at all be fixed in the machine.

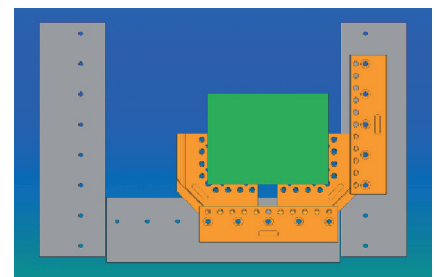

Example of use with two corner sets 85 (FT 01352)

F-Tool WEDM tooling system

Optimises wire EDMing with the new F-Tool wire tooling system

- Rationalisation through simple clamping
- Step ahead with smart solution

The new F-Tool WEDM tooling system is developing continuously to the needs of the end users.

The F-Tool WEDM clamping system provides:

- accurate and extensive clamping possibilities
- economic and extendable solutions
- palletisable clamping elements
- compatible solutions to existing tooling systems

F-Tool provides multifunctional clamping possibilities

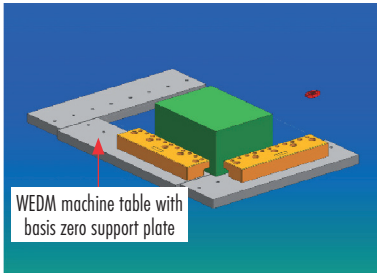

The basic ruler provides a reference stop and clamping beam for large parts and different F-Tool clamping elements.

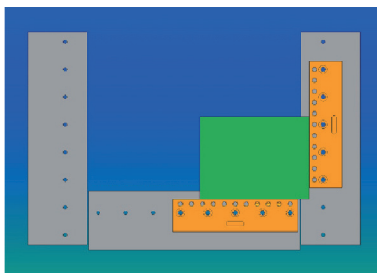
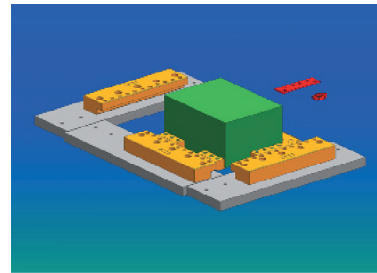

Large parts are clamped directly in aligned position.

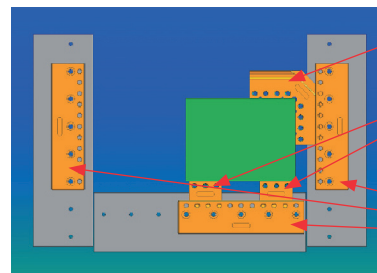

- FT 01352
- FT 01350
- FT 01347
- FT 01348
- FT 01349
- FT 01486
- FT 01487

With the F-Tool clamping assortment one can clamp collision-free and the free access to the work piece is warranted.

Multifunctional, economic and palletisable clamping elements set up the basis of the F-Tool WEDM tooling line

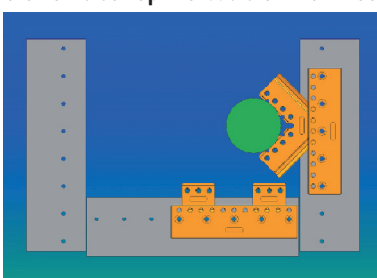

Example corner set 85 with round piece.

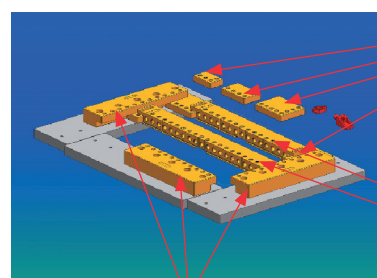

- FT 01568
- FT 01569
- FT 01570
- FT 01327
- FT 01063
- FT 01064
- FT 01065

FT 01347 FT 01349 FT 01487
FT 01348 FT 01486

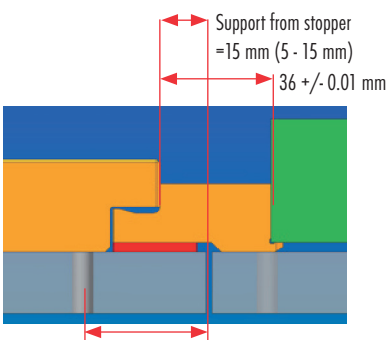

40 mm (30 - 40 mm)
Support distance machine table (variable)
Fixing hole M8 machine table

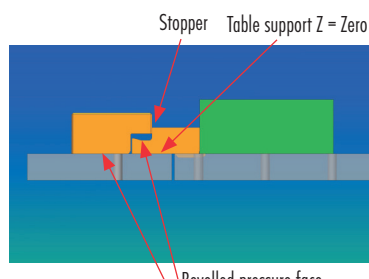

Stopper Table support Z = Zero
Bevelled pressure face
Machine table /
reference height zero

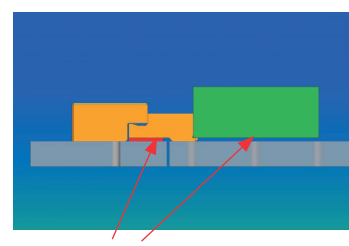

Reference height zero for clamping elements with clamping lips can be hoisted +3 mm with the spacer plate

The F-Tool clamping concept is solved simply and efficiently. By pulling the pressure screw tight, the clamping elements are clamped very strong and precise into the reference position. The basic rulers are compatible with all Wire EDM-machines with working table chuck Z-0.

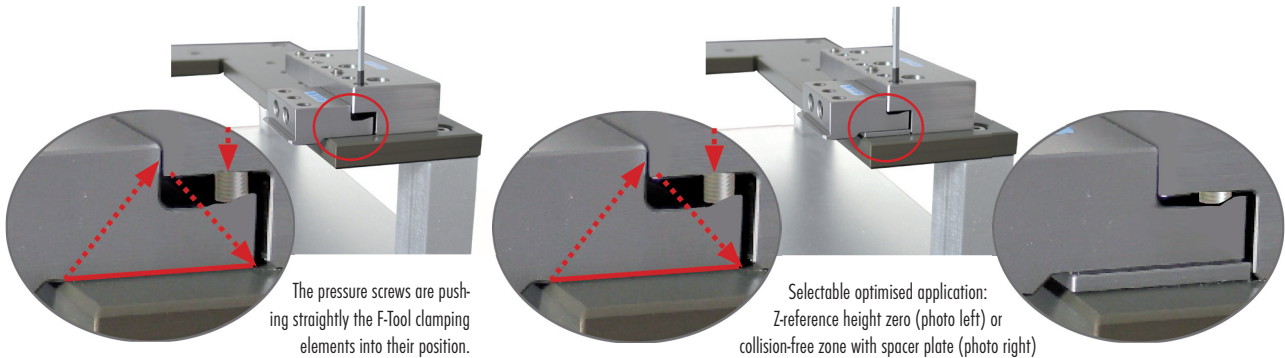

F-Tool WEDM basic sets

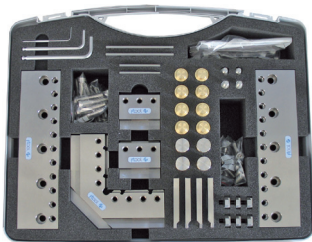

F-Tool ruler set

The F-Tool ruler set is an economic basis equipment for all wire EDM machines with basis zero table and hole pattern 50 mm M8.

The set contains: 2 x FT 01349 FT basic ruler 230 mm / 2 x FT 01350 FT front spanner / 1 x FT 01352 FT corner set 85 / 2 x FT 01376 stopper / 2 x FT 01457 Spacer Plate 100 x 29 x 3 mm, with 2 x hole Ø 9 mm / 2 x FT 01947 FTool Spacer plate 60 x 29 x h3 mm / comprehensive clamping appliances with support plates / brackets / screws / keys

Article no.	Article	Quantity	Weight	Code
FT 01344	FTool ruler set	1 set	10.60 kg	W
FT 02128	FTool ruler set Z+3mm	1 set	10.60 kg	W
FT 01342	FTool ruler set with basic ruler 230mm ML	1 set	10.60 kg	W

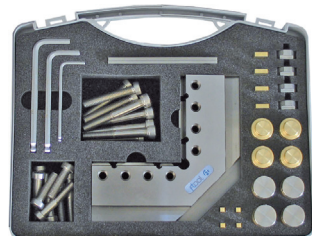

F-Tool corner set

The corner set is the perfect pallet for wire EDM plants. The corner set can be fixed left side, right side as well as frontal over 45°. The parts can be clamped outside the machine in the corner set and afterwards be clamped with the bead stops (basic ruler) in reference position of the machine. The clamping lips are lying in basic position on zero level. This zero level can be hoisted 3 mm with the spacer plates.

Dimension: leg length = 135 x 135 mm / height = 22 mm

The set contains: 1 x corner set / 2 x FT 01070 spacer plate 100 x 29 x 3 mm / screws / keys / brackets / support plates

Article no.	Article	Quantity	Weight	Code
FT 01352	FTool corner set 85	1 set	2.60 kg	W
FT 01420	FTool corner 85	1 piece	1.26 kg	W
FT 01675	FTool corner set 85 special with adjusting screws	1 set	2.60 kg	W
FT 01789	FTool corner set 85 special +3 mm	1 set	2.60 kg	W



F-Tool Corner basic set 14/85

The F-Tool corner basic set 14/85 is a simple, economic and flexible way to clamp the pieces in the wire cutting machine. The F-Tool corner 14/85 can be fixed in three different directions in the machine and can cut small as well as big work pieces with the best possible accessibility. The removable supporting bracket allows to cut the piece without any collision risk of the below wire guide in the highest precise and fastest zero position.

Article no.	Article	Quantity	Weight	Code
FT 01345	FTool Corner basic set 14/85	1 set	4.05 kg	W



F-Tool WEDM tool set

The WEDM tool set contains a practical assortment of corrosion-resistant screws, keys, brackets, support plates and bases. We recommend the set to every wire EDM user.

Article no.	Article	Quantity	Weight	Code
FT 01071	FTool WEDM tool set	1 set	4.07 kg	W

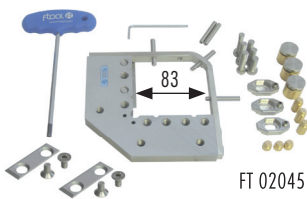

FT 02045

F-Tool Corner set 14/85 and 14/215 x 135

The F-Tool corner set 14/85 supports the direct insert in the basic rulers.

Article no.	Article	Quantity	Weight	Code
FT 02045	FTool Corner set 14/85 (with brackets and screws)	1 set	1.75 kg	W
FT 02044	FTool Corner 14/85 (without brackets and screws)	1 piece	1.37 kg	W
FT 02049	FTool Spacer plate 100 x 29 x h8 mm (for swivel head FT 01697)	1 piece	0.17 kg	W

Combination examples:

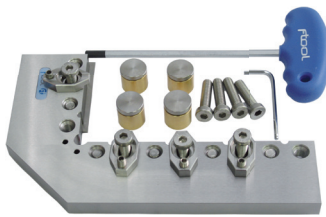
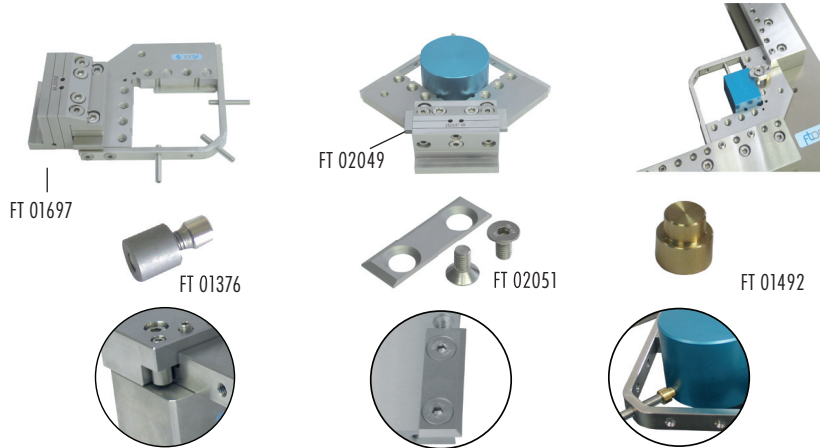

FT 02043

FT 02043 F-Tool corner set 14 / 215 x 135

The FT corner set 14 / 164 / 84 has a height of 14 mm and can be screwed directly under the basic rulers, sinistral or dexter according to requirements. The tensioning bracket made of hardened stainless steel is delivered with three pieces of FT 02051 Z-0 base plate 3.3 mm and miscellaneous clamping material. With the option FT 02097 brass corner jaw block you can clamp the work pieces without Z-base plates on Z-0, designed to preclude any collisions.

Article no.	Article	Quantity	Weight	Code
FT 02043	FTool Corner 14/164 x 84	1 piece	2.07 kg	W

Combination examples:

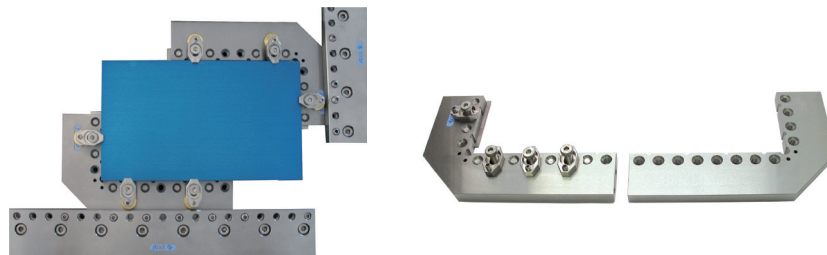

FT 02097 F-Tool brass corner jaw block

The brass corner jaw block is an easy tool to clamp work pieces on Z-0 levels and miscellaneous F-Tool clamping elements with hole grids 20 mm, designed to preclude any collisions.

Article no.	Article	Quantity	Weight	Code
FT 02097	FTool Brass corner jaw block M6 (set of 2 pieces)	1 set	0.23 kg	W

Combination example:

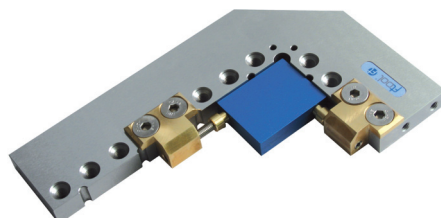

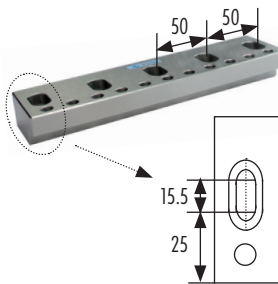
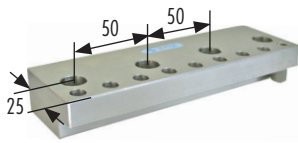

F-Tool basic ruler

The basic ruler are adjusted to the coordinate system of the machine and provide afterwards a fast clamping of work pieces or F-Tool pallets and clamping elements in reference position.

Dimension: length = x mm / width = 60 mm / height = 30 mm

The set contains: 1 x basic ruler / 1 x FT 01376 stopper / the required attachment and pressure screws (FT 01373)

Article no.	Article	Quantity	Weight	Code
FT 01347	FTool basic ruler 140 mm	1 piece	1.75 kg	W
FT 01348	FTool basic ruler 180 mm	1 piece	2.30 kg	W
FT 01349	FTool basic ruler 230 mm	1 piece	2.80 kg	W
FT 01486	FTool basic ruler 320 mm	1 piece	3.90 kg	W
FT 01487	FTool basic ruler 380 mm	1 piece	4.70 kg	W

Basic ruler with long slot:

FT 01858	FTool basic ruler 140 mm ML	1 piece	1.65 kg	W
FT 01859	FTool basic ruler 180 mm ML	1 piece	2.20 kg	W
FT 01780	FTool basic ruler 230 mm ML	1 piece	2.70 kg	W
FT 01860	FTool basic ruler 320 mm ML	1 piece	3.80 kg	W
FT 01820	FTool basic ruler 380 mm ML	1 piece	4.42 kg	W



F-Tool side spanner

The F-Tool side spanner has two bearing sides and provides a support of larger plates. The side spanner is suited excellent in combination with the corner set 85 (FT 01352) or with the front spanner (FT 01350).

Dimension: 215 x 50 mm / height = 22 mm

The set contains: 1 x side spanner / 1 x FT 01439 spacer plate 60 x 20 x 3 mm

Article no.	Article	Quantity	Weight	Code
FT 01351	FTool side spanner	1 piece	1.43 kg	W

Combination examples:

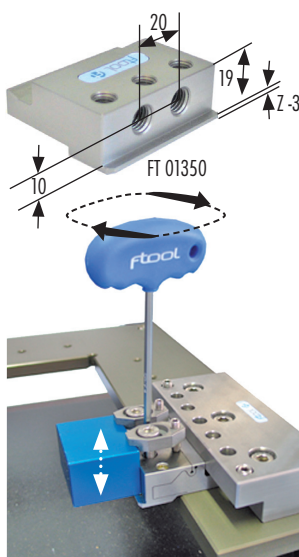
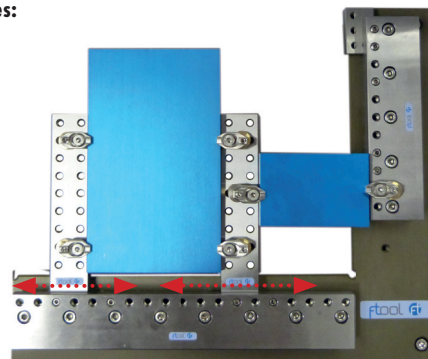

F-Tool front spanner

The front spanner provides a support plate for small parts or can be used in combination with the side spanner (FT 01351), the corner set 85 (FT 01352) or with the distance support mini (FT 01066). The clamping lip lies in basic position on zero level. This zero level can be hoisted 3 mm with the spacer plates.

Dimension: 55 x 60 mm / height = 22 mm

The set contains: 1 x front spanner / 2 x FT 01382 F-Tool bracket ER34 corrosion-resistant

Article no.	Article	Quantity	Weight	Code
FT 01350	FTool front spanner	1 piece	0.43 kg	W
FT 01790	FTool front spanner special +3 mm	1 piece	0.48 kg	W
FT 01690	FTool front spanner Z-Vario	1 piece	0.60 kg	W

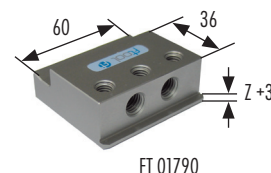
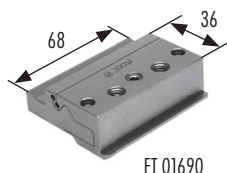

The front spanner Z-Vario (FT 01690) is continuously adjustable ca 0.2 mm

The Mini universal plate, to clamp thin plates in the FTool RulerSet

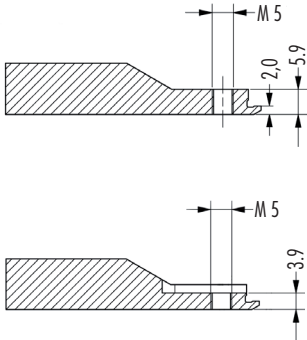
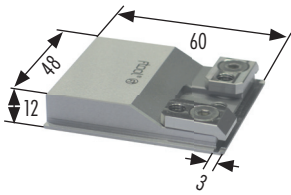

F-Tool Mini universal clamping plate

The Mini Universal clamping plate, to fix thin plates in the FTool RulerSet. The z-lip supports are just +2 mm above the 0-level to avoid any collision with the flushing nozzle. The z-lips on both sides of the clamping plate give a high flexible application range. The clamping plate can be mounted as a single-, or over the corner as a multifunctional clamping device. The Mini clamping plate is delivered with two Mini brackets.

Article no.	Article	Quantity	Weight	Code
FT 01951	FTool Mini Universal clamping plate Z+2// 60 x 54 x 12 mm	1 piece	0.26 kg	W
FT 01952	Mini Bracket 22 x 13 x 3.8 mm	1 piece	0.05 kg	W

Combination examples:

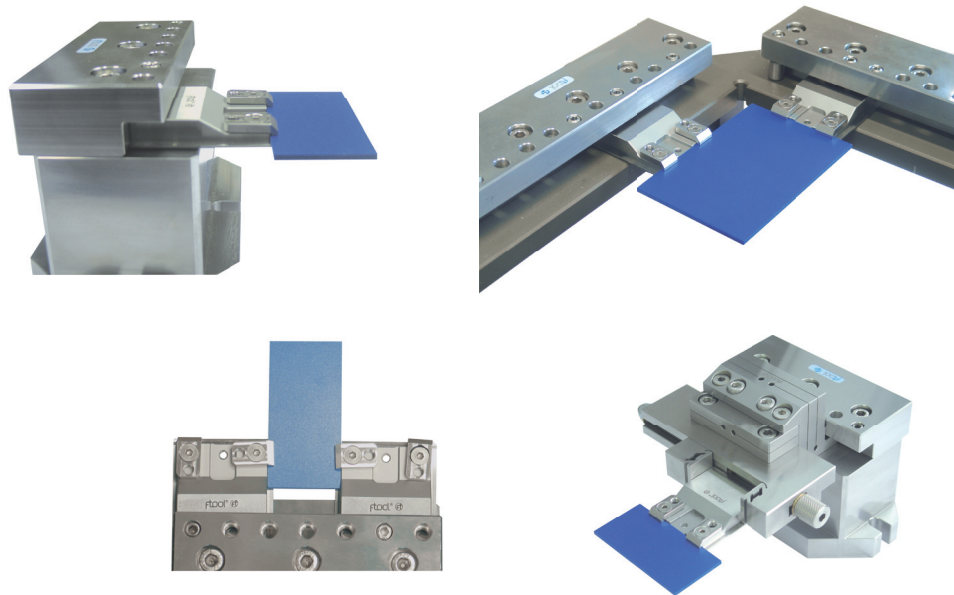

F-Tool Clamping block, the bridge from Presetting to EDM drilling to EDM- and wire EDMing.

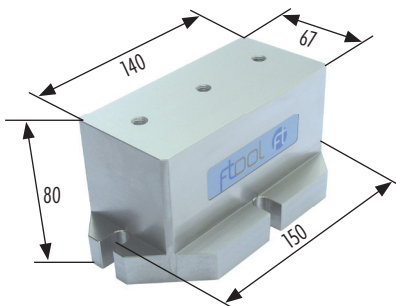

Clamping block

The Clamping block can be used as a basement on the EDM, EDM-drilling and Presetting machines. On the top surface the FT 01347 Basic Ruler 140 mm can be fitted. The clamping block is a high accurate clamping surface for workpieces and fixtures for RulerSet equipments.

Article no.	Article	Quantity	Weight	Code
FT 01945	Clamping block h80	1 piece	6.78 kg	B
FT 01347	FTool basic ruler 140 mm	1 piece	1.75 kg	W

Combination examples:

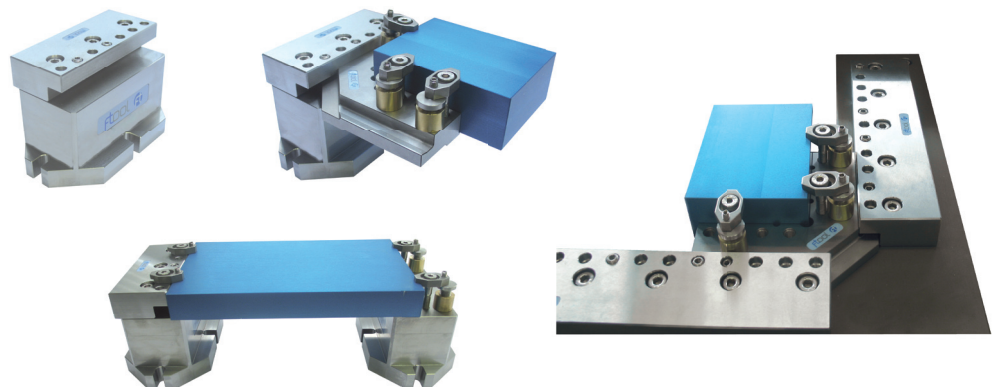

3D swivel head multifunctional

Simple adjustment in three independant axes.
Choose your combination with a couple of grips.

Fast, precise and three-dimensional adjustment. Among many F-Tool clamping elements it's also compatible to EROWA and 3R systems. The swivel head can be prepared and adjusted outside the machine on a presetting station and clamped on the F-Tool basic ruler on the machine table.

flexible
practical
economic

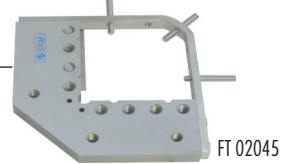
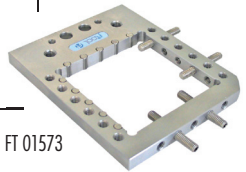
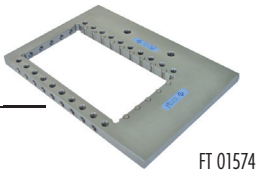
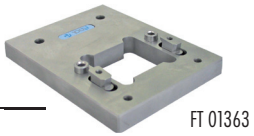
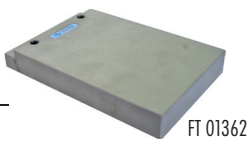
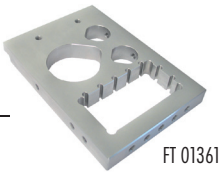
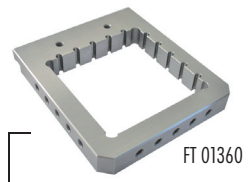
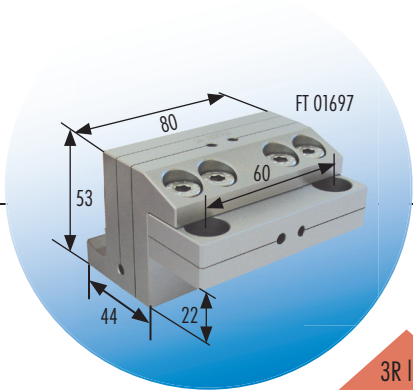
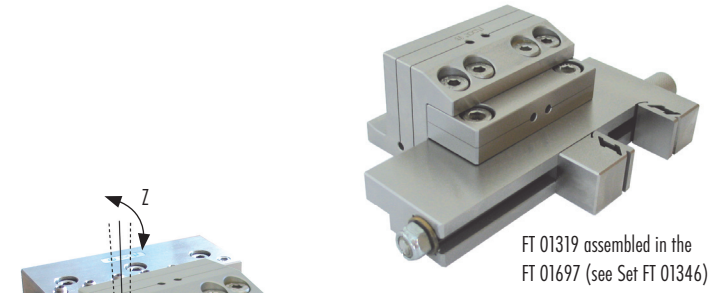

3R link

3R link

ER link

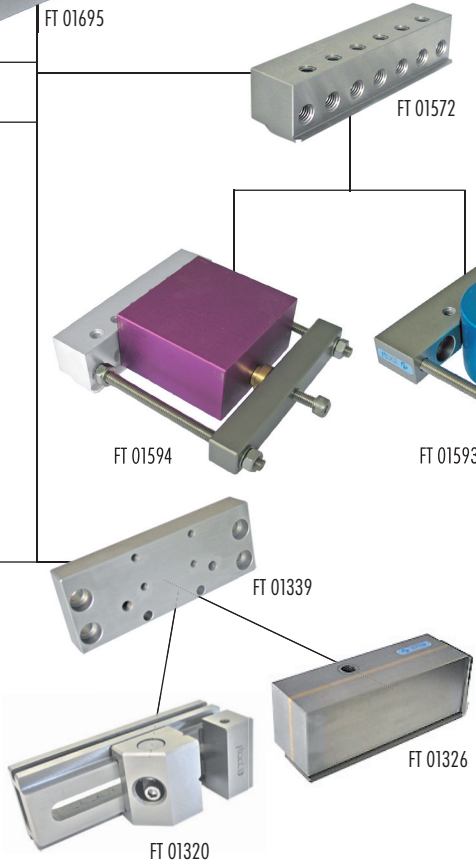
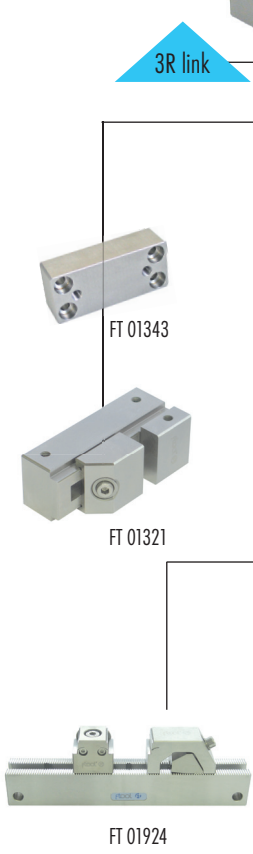

F-Tool WEDM basic sets

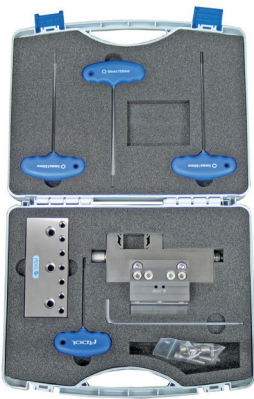

F-Tool 3D ViseSet 100

Fast, precise and three-dimensional adjustment.

A universal and multifunctional set. Quick assembling with the basic ruler 140 mm. Compatible to WEDM-machines with Z-reference height 0.

The set contains:

- 1 x FT 01697 3D swivel head IF 22
- 1 x FT 01319 vise 100F22

- 1 x FT 01347 basic ruler 140 mm
- diverse screws and keys

→ delivered in a synthetic case

Article no.	Article	Quantity	Weight	Code
FT 01346	FTool 3D ViseSet 100	1 set	5.04 kg	W

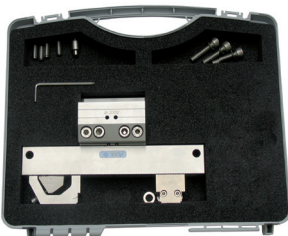

FTool 3D ViseSet 220B28

Fast, precise and three-dimensional adjustment.

Flexible machining of cubic pieces of miscellaneous sizes in Z-zero position. Accurate, strong and centrally clamping, simplifies the adjustment.

Maximal clamping size: 130 mm, Maximal workpiece size: 130 x 100 x 100 mm, Maximal weight: 10 kg

Article no.	Article	Quantity	Weight	Code
FT 02046	FTool 3D ViseSet 220B28	1 set		W

Combination examples:

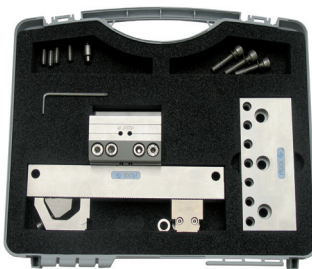

FTool 3D ViseSet 220B28 incl. basic ruler 140 mm

Fast, precise and three-dimensional adjustment.

Flexible machining of cubic pieces of miscellaneous sizes in Z-zero position. Accurate, strong and centrally clamping, simplifies the adjustment.

Maximal clamping size: 130 mm, Maximal workpiece size: 130 x 100 x 100 mm, Maximal weight: 10 kg

Article no.	Article	Quantity	Weight	Code
FT 02047	FTool 3D ViseSet 220B28 incl. basic ruler 140 mm	1 set	5.66 kg	W

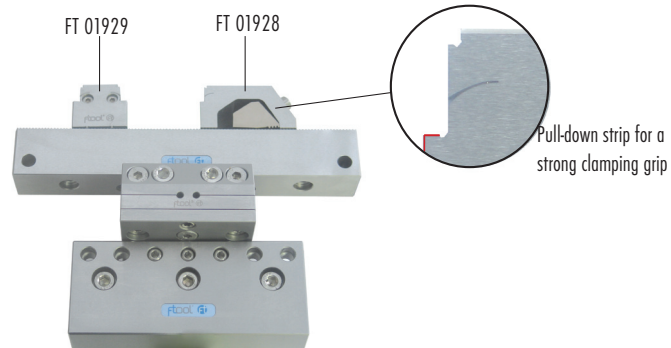

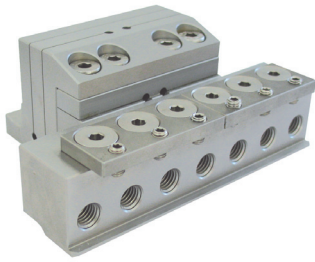

F-Tool 3D swivel head with front spanner 140

The F-Tool 3D swivel head with front spanner 140 is delivered completely with screws, brackets and allen keys. The prism holder (FT 01593) and the yoke 140 mm (FT 01594) can be fixed frontal into the FT 01693. The yoke can be used directly on the beams and on the front spanner to clamp square pieces as well.

Article no.	Article	Quantity	Weight	Code
FT 01693	FTool 3D swivel head with front spanner 140	1 piece	2.78 kg	W
Options:				
FT 01593	FTool prism holder 110 mm complete	1 piece	1.50 kg	W
FT 01594	FTool prism holder 110 mm complete	1 piece	0.65 kg	W

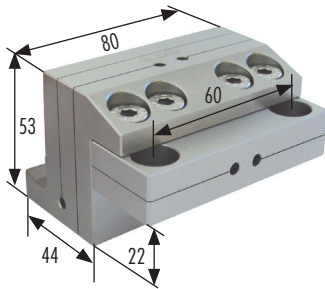

F-Tool 3D swivel head IF 22

The 3D swivel head IF 22 can be used in combination with many F-Tool clamping elements. Furthermore, this article is compatible with some EROWA PalletSet W elements.

Article no.	Article	Quantity	Weight	Code
FT 01697	FTool 3D swivel head IF 22	1 piece	1.43 kg	W
Options:				
FT 01318	FTool vise 55F18	1 piece	1.07 kg	W
FT 01319	FTool vise 100F22	1 piece	1.43 kg	W
FT 01358	FTool spacer plate 100 x 29 x H 4 mm	1 piece	0.11 kg	W
FT 01360	FTool frame pallet 100 x 22 mm	1 piece	3.28 kg	W
FT 01361	FTool universal pallet 22 mm	1 piece	3.80 kg	W
FT 01362	FTool blank pallet 22 mm	1 piece	2.75 kg	W
FT 01363	RefTool IF pallet 14 mm	1 piece	1.34 kg	W
FT 01448	Spacer plate 100 x 29 x H 12 mm	1 piece	0.31 kg	W
FT 01573	FTool frame pallet 75 x 75 x 10 mm without clamping beam	1 piece	0.85 kg	W
FT 01574	FTool frame pallet 135 x 75 x 10 mm without clamping beam	1 piece	1.50 kg	W

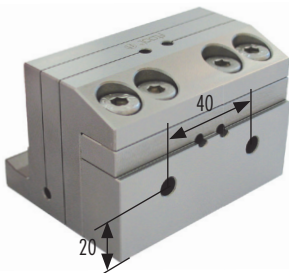

F-Tool 3D swivel head IF 90°

The 3D swivel head IF 90° is used for the frontal collet of clamping elements and adapter plates.

Article no.	Article	Quantity	Weight	Code
FT 01705	FTool 3D swivel head IF 90°	1 piece	1.48 kg	W
Options:				
FT 01320	FTool vise 80VL50	1 piece	1.40 kg	W
FT 01321	FTool vise 20VL24	1 piece	0.26 kg	W
FT 01326	FTool magnetic table 140 x 50 x 44 mm	1 piece	2.60 kg	W
FT 01339	Interface plate 146 x 56 x 16 mm	1 piece	1.30 kg	W
FT 01343	Interface uniplate for vise 20VL24	1 piece	0.22 kg	W

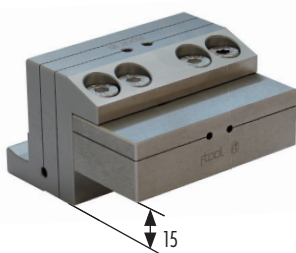

F-Tool 3D swivel head IF 15 / 3R

Compatible with many 3R clamping elements.

Article no.	Article	Quantity	Weight	Code
FT 01706	FTool 3D swivel head IF 15 / 3R	1 piece	1.39 kg	W

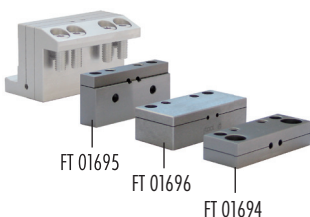

F-Tool Adapter to swivel head

For every application the right adapter.

Article no.	Article	Quantity	Weight	Code
FT 01694	IF 22 for 3D swivel head	1 piece	0.24 kg	W
FT 01695	IF 90° for 3D swivel head	1 piece	0.34 kg	W
FT 01696	IF 15 / 3R for 3D swivel head	1 piece	0.26 kg	W

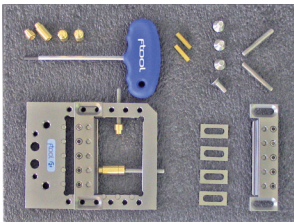

F-Tool frame pallet

The F-Tool frame pallet 75 x 75 x 10 mm has a height of 10 mm only and is suited for the collet of thin plates <75 x 75 mm. The parts can be clamped with M6 screws sideways on plan-eroded pins. Parallel grinded plates with unmachined side faces can be clamped accurate on small support beams. The frame pallet can be inserted directly in the corner set 85, in the palletset W adapter, the F-Tool swivel table with IF 22 or in the ER swivel. The frame pallet is delivered completely with screws and 2 small clamping beams.

Pallet dimension: 130 x 105 x 10 mm

Clamping beam height: lips = -2 mm / strip from height zero = 16 mm

Article no.	Article	Quantity	Weight	Code
FT 01353	FTool frame pallet 75 x 75 x 10 mm with clamping beam	1 piece	1.20 kg	W
FT 01573	FTool frame pallet 75 x 75 x 10 mm without clamping beam	1 piece	0.85 kg	W

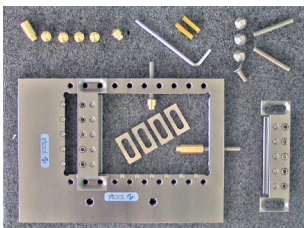

F-Tool frame pallet

The F-Tool frame pallet 135 x 75 x 10 mm has a height of 10 mm only and is suited for the collet of thin plates <135 x 75 mm. The parts can be clamped with M6 screws sideways on plan-eroded pins. Parallel grinded plates with unmachined side faces can be clamped on small support beams. The frame pallet can be clamped directly with the basic ruler or be inserted in the F-Tool swivel table IF 22. The frame pallet is delivered completely with screws and 2 small clamping beams.

Pallet dimension: 195 x 137 x 10 mm

Clamping beam height: lips = -2 mm / strip from height zero = 16 mm

Article no.	Article	Quantity	Weight	Code
FT 01444	FTool frame pallet 135 x 75 x 10 mm with clamping beam	1 piece	1.90 kg	W
FT 01574	FTool frame pallet 135 x 75 x 10 mm without clamping beam	1 piece	1.50 kg	W

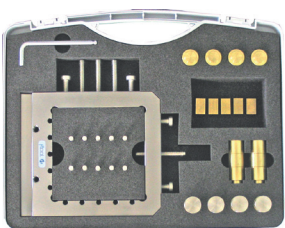

F-Tool frame pallet

The frame pallet 100 x 22 mm is an economic, universal clamping frame with variable clamping possibilities. The clamping frame can be charged with parts very simple outside the machine on a flat surface. Afterwards the clamping frame, charged with parts, is available for the handling with a few hand grips. The base frame consists of corrosion-resistant, not hardened high-grade steel. The surface or the provided hardened, corrosion-resistant cylinder bolts provide optionally a stopper for the parts. The clamping beam is delivered completely with screws, keys, cylinder bolts and jacks.

Pallet dimension 170 x 150 x 22 mm

Article no.	Article	Quantity	Weight	Code
FT 01360	FTool frame pallet 100 x 22 mm	1 piece	3.28 kg	W

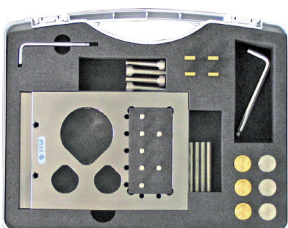

F-Tool universal pallet

The universal pallet is a multifunctional clamping frame for round and square parts. The universal pallet can be charged with parts very simple outside the machine on a flat surface, like the frame pallet, and is available anytime for the application on the machine. The base frame consists of corrosion-resistant, not hardened high-grade steel. The surface or the provided hardened, corrosion-resistant cylinder bolts provide optionally a stopper for the parts. The universal pallet is delivered completely with screws, keys, cylinder bolts and jacks.

Pallet dimension: 200 x 140 x 22 mm

Article no.	Article	Quantity	Weight	Code
FT 01361	FTool universal pallet 22 mm	1 piece	3.80 kg	W

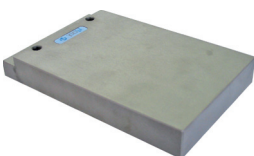

F-Tool blank pallet

The end user can cut his forms by himself analog the universal pallet or the frame pallet.

Pallet dimension: 160 x 100 x 22 mm

Article no.	Article	Quantity	Weight	Code
FT 01362	FTool blank pallet 22 mm	1 piece	2.75 kg	W

Combination examples:

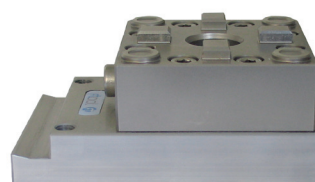

FT 01044
chuck 80 IF3R
FT 01362 blank
pallet 22 mm

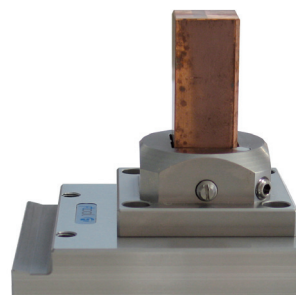

FT 01765 square 25
front part
FT 01362 blank
pallet 22 mm

RefTool IF pallet



RefTool IF pallet

With the RefTool IF pallet, electrodes can be handled on the RefTool holders in reference position with the wire EDM machine. The RefTool IF pallet is delivered completely with screws and keys.

Pallet dimension: 130 x 100 x 14 mm

Article no.	Article	Quantity	Weight	Code
FT 01363	RefTool IF pallet 14 mm	1 piece	1.34 kg	W

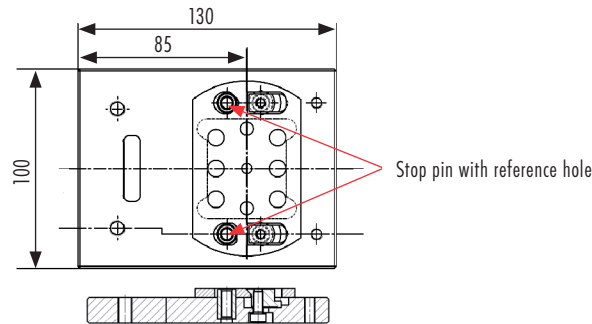

F-Tool WEDM vises and magnetic tables

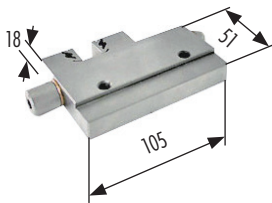

F-Tool vise 55F18

Handy, flat accurate vise (18 mm) with pull-down spring return effect for wire EDM plants. Can be inserted in the F-Tool ruler set, in the ER swivel, in the swivel table or in the palletset W. Made of corrosion-resistant, hardened high-grade steel.

Clamping length: 55 mm, clamping height: 18 mm

Article no.	Article	Quantity	Weight	Code
FT 01318	FTool vise 55F18	1 piece	1.07 kg	W

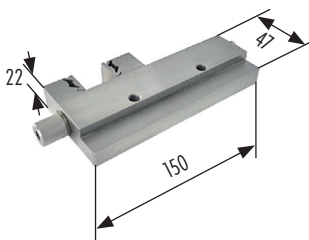

F-Tool vise 100F22

Handy, flat accurate vise (22 mm) with pull-down spring return effect for wire EDM plants. Can be inserted in the F-Tool ruler set, in the ER swivel, in the swivel table or in the palletset W. Made of corrosion-resistant, hardened, grinded high-grade steel.

Clamping length: 100 mm, clamping height: 22 mm

Article no.	Article	Quantity	Weight	Code
FT 01319	FTool vise 100F22	1 piece	1.43 kg	W

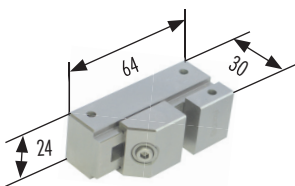

F-Tool vise 20VL24

Small accurate vise made of corrosion-resistant, hardened, grinded high-grade steel for EDM and wire EDM machines.

Hole pattern from behind: 4 x M5 / 16 x 52 mm

Clamping length: 20 mm, clamping height: 24 mm

Article no.	Article	Quantity	Weight	Code
FT 01321	FTool vise 20VL24	1 piece	0.26 kg	W

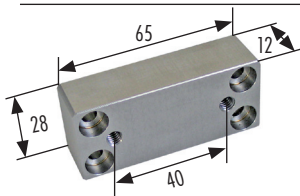

F-Tool interface uniplate for vise 20VL24

On the front side, the vise 20VL24, hole pattern (4 x 5.8 / 16 x 52 mm), on the back side, the F-Tool ER plate (FT 01435) or the uniplate (FT 01079 / FT 01080) can be assembled, hole pattern (2 x M6 / 40 mm).

Article no.	Article	Quantity	Weight	Code
FT 01343	FTool interface uniplate for vise 20VL24	1 piece	0.22 kg	W

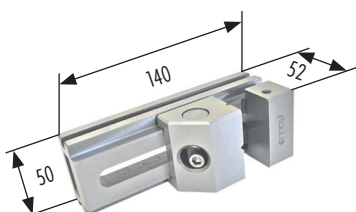

F-Tool vise 80VL50

Accurate vise made of corrosion-resistant, hardened, grinded high-grade steel for EDM and wire EDM machines.

Hole pattern from behind: 4 x M8 / 25 x 127 mm

Clamping length: 80 mm, clamping height: 50 mm

Article no.	Article	Quantity	Weight	Code
FT 01320	FTool vise 80VL50	1 piece	1.40 kg	W

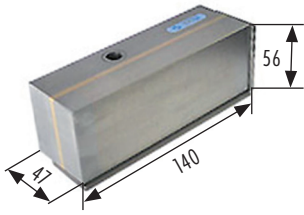

F-Tool magnetic table 140 x 50 x 44 mm

Small, corrosion-resistant magnetic table for the insertion on EDM, wire EDM and grinding machines.
Hole pattern from behind: 4 x M8 / 25 x 127 mm

Article no.	Article	Quantity	Weight	Code
FT 01326	FTool magnetic table 140 x 50 x 44 mm	1 piece	2.60 kg	W

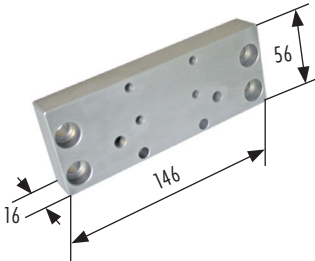

F-Tool interface plate

Multiple applicable interface plate.

Back side mountable

WEDM angle QC50 (FT 01337)
FTool swivel interface 90° (FT 01359)
FTool ER plate (FT 01435)
Uniplate (FT 01079 / FT 01080)

Front side mountable

FTool vise 80VL50 (FT 01320)
FTool magnetic table 140 x 50 x 44 mm (FT 01326)
Fixtures with hole pattern 4 x M8 / 25 x 127 mm SH 28 mm

Article no.	Article	Quantity	Weight	Code
FT 01339	FTool interface plate 146 x 56 x 16 mm	1 piece	1.30 kg	W

Combination examples:

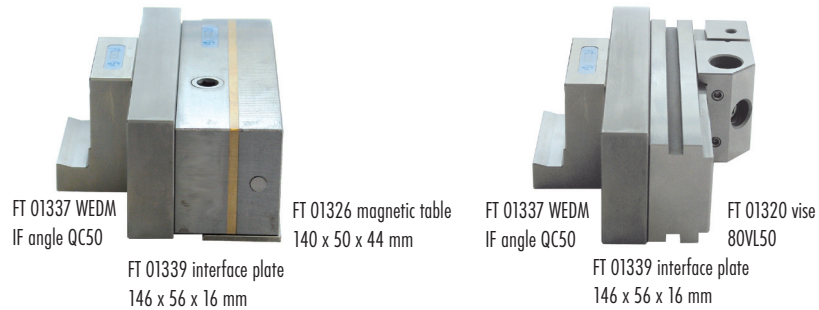

FT 01337 WEDM IF angle QC50

FT 01326 magnetic table 140 x 50 x 44 mm

FT 01337 WEDM IF angle QC50

FT 01320 vise 80VL50

FT 01339 interface plate 146 x 56 x 16 mm

FT 01339 interface plate 146 x 56 x 16 mm

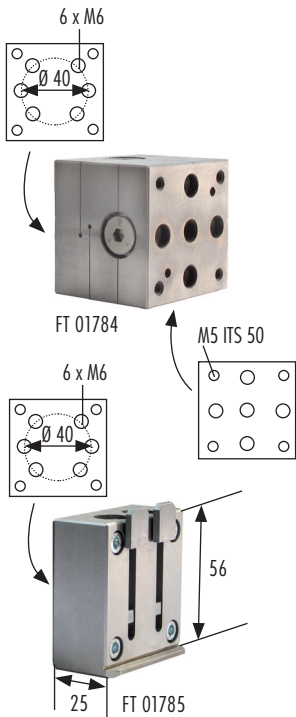

F-Tool swivel block 56 and WEDM vise V 0-75 mm

Made of corrosion-resistant, hardened stainless steel. Vise delivered with clamping jaws for the stress area of 0-75 mm.
Hole pattern appropriate to electrode holders with hole distance for M6 distance 40 mm.

Article no.	Article	Quantity	Weight	Code
FT 01784	FTool swivel block 56	1 piece	0.74 kg	W
FT 01785	FTool WEDM vise V 0-75 mm	1 piece	0.63 kg	W

Appropriate for the assembling on:

FT 01337	FTool WEDM IF angle QC50	1 piece	0.61 kg	W
FT 01435	FTool ER-plate EWIS	Set of 10 pieces	4.50 kg	A
FT 01727	FTool PIN pallet aluminium Ø 80 mm	1 piece	0.34 kg	P

Combination examples:

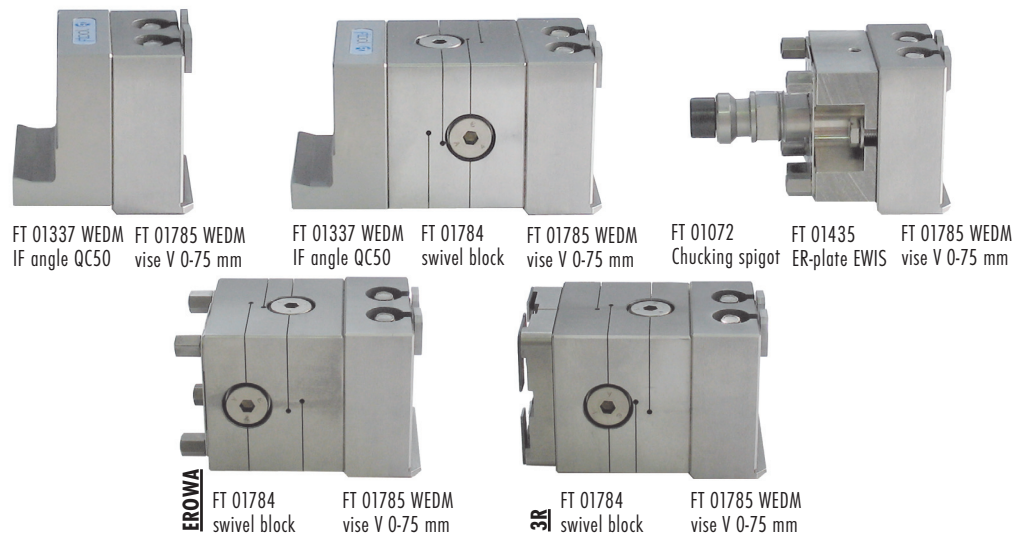

FT 01337 WEDM IF angle QC50

FT 01785 WEDM vise V 0-75 mm

FT 01337 WEDM IF angle QC50

FT 01784 swivel block

FT 01785 WEDM vise V 0-75 mm

FT 01072 Chucking spigot

FT 01435 ER-plate EWIS

FT 01785 WEDM vise V 0-75 mm

EROWA

FT 01784 swivel block

FT 01785 WEDM vise V 0-75 mm

3R

FT 01784 swivel block

FT 01785 WEDM vise V 0-75 mm

F-Tool MultiClamp, with link to the RulerSet

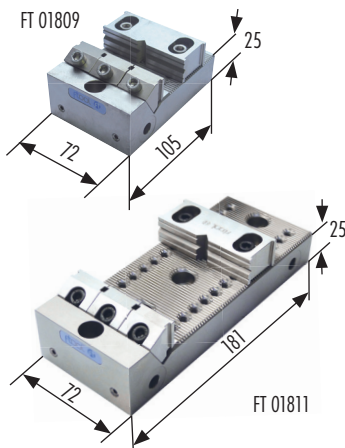

F-Tool MultiClamp 105 and 181

The F-Tool MultiClamp is a pull-down clamp with adjustable, hardened pull-down and stop jaws. It is corrosion-resistant and hardened. The stop jaw can be set every 2 mm in the tooth grid. The support surface is put up on 25 ± 0.01 mm. The F-Tool MultiClamp fits for the insert as a multiple clamp on the T-slot pallet, ITS/UPC pallet and square block. The maximum clamping range on the MultiClamp 105 is 48 mm, on the MultiClamp 181//124 mm. The clamp travel of the clamping jaw is 3 mm.

Article no.	Article	Quantity	Weight	Code
FT 01809	FTool PIN MultiClamp 105 x 72 mm B40, corrosion-resistant	1 piece	1.90 kg	P
FT 01811	FTool PIN MultiClamp 181 x 72 mm B40, corrosion-resistant	1 piece	2.94 kg	P
FT 01878	Basic Ruler IF100/50	1 piece	0.84 kg	W

Combination examples:

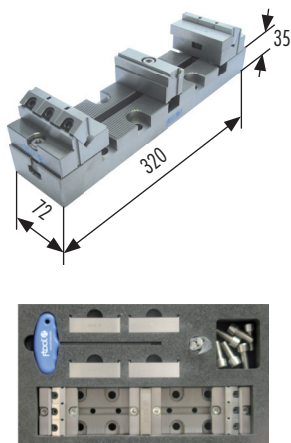
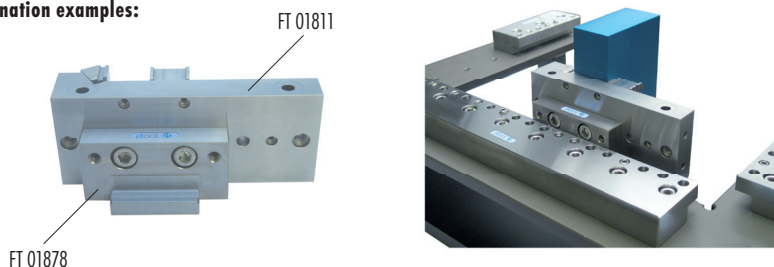

WEDM ClampingBeam B72

The MC railer set 320 B72 is a perfect, upgradable basic initial equipment for general multiple-clamping-jobs in the daily business. The hole grid 50 mm matches for the direct assembling on UPC pallets. Max. clamping power 10 - 15 KN

Article no.	Article	Quantity	Weight	Code
FT 01857	FTool MC Railer Set 320 B72	1 set	8.87 kg	P
FT 01878	Basic Ruler IF100/50	1 piece	0.84 kg	W

Combination examples:

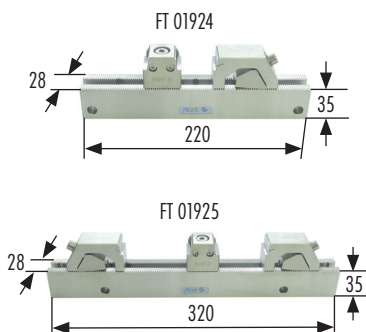
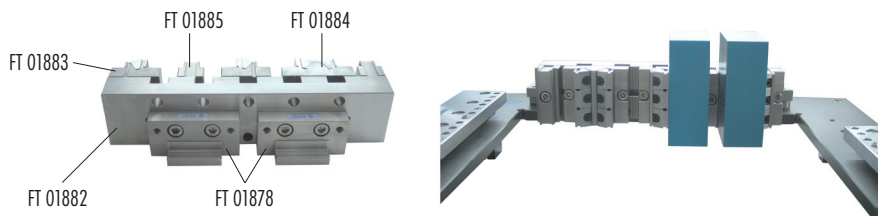

WEDM ClampingBeam B28

The WEDM railer is prepared with a disc pull-down-system and a quickly adjustable clamping-slide. With the help of the basic rulers IF FT 01873 or with the two fixing holes $\varnothing 9$ D200, the railer can be clamped horizontal in the EDM wire cutting machine. Maximal holding capacity B220 B28 = 130 mm, B320 B28 = 2 x 0-88 mm or 1 x 0-230 mm

Article no.	Article	Quantity	Weight	Code
FT 01924	WEDM clamping beam 220B28 with sliding jaws B28WEDM	1 piece	1.80 kg	P
FT 01925	WEDM clamping beam 320B28 with sliding jaws B28WEDM	1 piece	2.70 kg	P
FT 01873	Basic Ruler IF100/30	1 piece	0.55 kg	W

Combination examples:

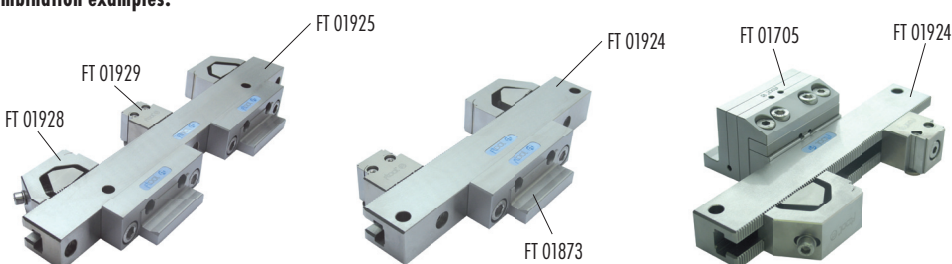

F-Tool WEDM pendulum holder

With the pendulum holder, work pieces can be aligned independent with 2 screws (per level) in the X- and Y-level. The pendulum holder can be clamped directly on the zero level of the machine table or underneath the basic ruler. To adapt the several clamping elements, two different adapter types are available:

- a) the adapter for rather flat collets, the interface 22 (IF 22)
- b) the adapter for rather high collets, the interface 90° (IF 90°)

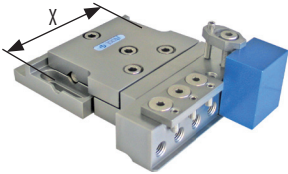

F-Tool swivel table

Pendulum-table (adjustment table) with receiver. The clamping lip lies in basis zero level. When there is risk of collision, the pendulum-table can be hoisted by 3 mm with the spacer plate (FT 01070).

Hole distance: X = 100 mm

The set contains: swivel table with front spanner / spacer plate 3 mm (FT 01070) / miscellaneous screws, keys and brackets
 → The swivel table is delivered in the same plastic case like e.g. article no. FT 01354

Article no.	Article	Quantity	Weight	Code
FT 01571	FTool swivel table with front spanner 140 x 30 x 35 mm	1 piece	4.40 kg	W

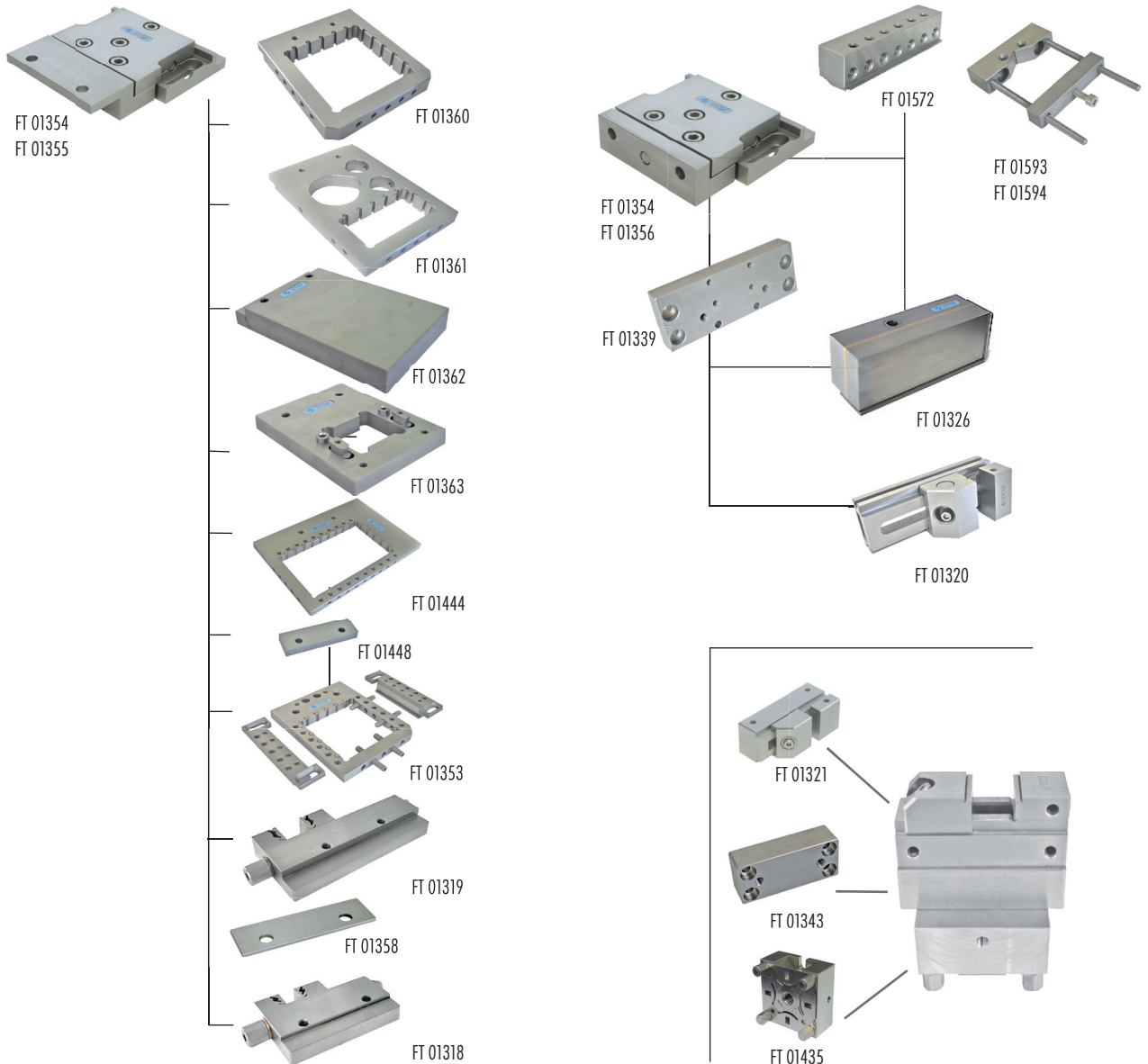

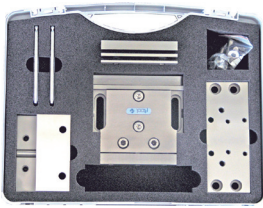

F-Tool swivel table complete

Complete adjustment table with all cutting sites for high or flat clamping elements.

Hole distance: X = 100 mm

The set contains: swivel table with IF 22 (FT 01357) and IF 90° (FT 01359) / spacer plate 3 mm (FT 01070) / spacer plate 4 mm (FT 01358) / spacer plate 12 mm (FT 01448) / interface plate 146 x 56 x 12 mm (FT 01339) / miscellaneous screws and keys

Article no.	Article	Quantity	Weight	Code
FT 01354	FTool swivel table complete	1 piece	5.28 kg	W

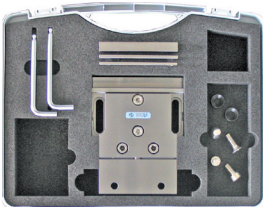

F-Tool swivel table with IF 22

Basic equipment F-Tool adjustment table to adapt predominantly flat clamping elements.

Installation size: 175 x 120 x 30 mm / hole distance: X = 100 mm

The set contains: swivel table with IF 22 / spacer plate 3 mm (FT 01070) / spacer plate 4 mm (FT 01358) / spacer plate 12 mm (FT 01448) / miscellaneous screws and keys

Article no.	Article	Quantity	Weight	Code
FT 01355	FTool swivel table with IF 22	1 piece	3.70 kg	W



F-Tool swivel interface 90°

For the frontal collet of miscellaneous clamping elements or work pieces. As option to the swivel table IF 22 (FT 01355).

Article no.	Article	Quantity	Weight	Code
FT 01359	FTool swivel interface 90°	1 piece	0.65 kg	W

→ Delivered with cylinder bolt and miscellaneous screws

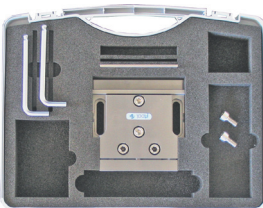

F-Tool swivel table with IF 90°

Basic equipment adjustment table to adapt predominantly high clamping elements and for the frontal collet of miscellaneous clamping elements or work pieces.

Installation size: 145 x 120 x 30 mm / hole distance: X = 100 mm

The set contains: swivel table with IF 90° / spacer plate 3 mm (FT 01070) / miscellaneous screws and keys

Article no.	Article	Quantity	Weight	Code
FT 01356	FTool swivel table with IF 90°	1 piece	3.10 kg	W

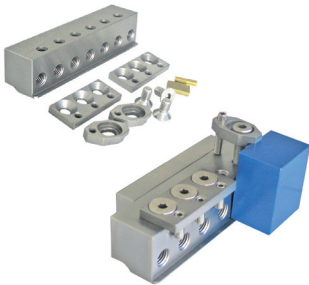

F-Tool front spanner

For the direct collet of miscellaneous work pieces. As option to the swivel table IF 90° (FT 01356), to the 3D swivel with front spanner (FT 01693) and to the WEDM square block-index-table 80 (FT 01791).

Article no.	Article	Quantity	Weight	Code
FT 01572	FTool front spanner 140 x 30 x 35 mm complete with brackets	1 piece	1.46 kg	W

→ Delivered with miscellaneous screws, keys, insert plates, distance pieces and brackets



F-Tool swivel interface 22

For the collet of miscellaneous flat clamping elements. As option to the swivel table IF 90° (FT 01356).

Article no.	Article	Quantity	Weight	Code
FT 01357	FTool swivel interface 22	1 piece	0.85 kg	W

→ Delivered with cylinder bolt and miscellaneous screws

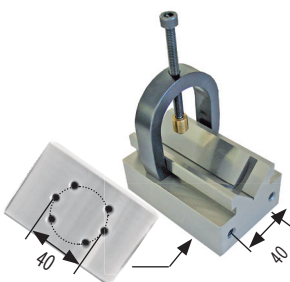

F-Tool V-block corrosion-resistant

The V-Block is qualified for the fast clamping of arbors, punches and pushers up to Ø 32 mm. It can be assembled frontally or from the back on diverse F-Tool holders. The best compatibility is with the uniplate EWIS (FT 01080), the F-Tool ER-plate EWIS (FT 01435), the F-Tool basic plate IF3R (FT 01135) and the F-Tool universal index adapter plate 80 with graduation (FT 01792). For the application on EDM, WEDM and grinding machines.

Article no.	Article	Quantity	Weight	Code
FT 01679	FTool V-block corrosion-resistant	1 piece	1.64 kg	W

Hole pattern from the bottom

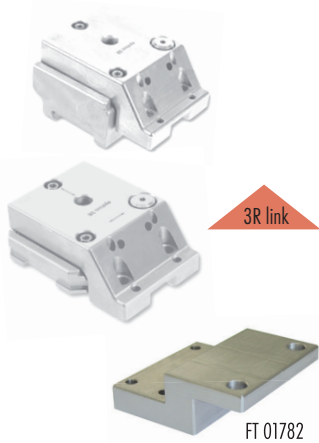

F-Tool swivel interface 3R 22

This swivel interface 3R 22 is useful to integrate the practical and economic F-Tool frame pallets and vises into the 3R system.

Article no.	Article	Quantity	Weight	Code
FT 01782	Ftool swivel interface 3R 22	1 piece	0.93 kg	B
Options:				
FT 01318	Ftool vise 55F18	1 piece	1.07 kg	W
FT 01319	Ftool vise 100F22	1 piece	1.43 kg	W
FT 01358	Ftool spacer plate 100 x 29 x H 4 mm	1 piece	0.11 kg	W
FT 01360	Ftool frame pallet 100 x 22 mm	1 piece	3.28 kg	W
FT 01361	Ftool universal pallet 22 mm	1 piece	3.80 kg	W
FT 01362	Ftool blank pallet 22 mm	1 piece	2.75 kg	W
FT 01363	RefTool IF pallet 14 mm	1 piece	1.34 kg	W
FT 01448	Ftool Spacer plate 100 x 29 x H 12 mm	1 piece	0.31 kg	W
FT 01573	Ftool frame pallet 75 x 75 x 10 mm without clamping beam	1 piece	0.85 kg	W
FT 01574	Ftool frame pallet 135 x 75 x 10 mm without clamping beam	1 piece	1.50 kg	W

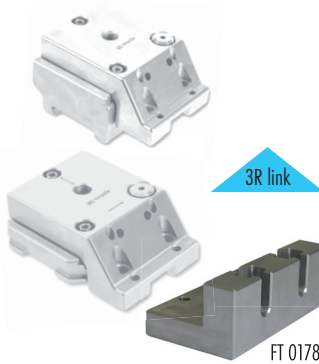

F-Tool swivel interface 3R 90°

This swivel interface 3R 90° is useful to integrate a great many of F-Tool clamping pieces into the 3R system.

Article no.	Article	Quantity	Weight	Code
FT 01783	Ftool swivel interface 3R 90°	1 piece	0.96 kg	B
Options:				
FT 01320	Ftool vise 80VL50	1 piece	1.40 kg	W
FT 01321	Ftool vise 20VL24	1 piece	0.26 kg	W
FT 01326	Ftool magnetic table 140 x 50 x 44 mm	1 piece	2.60 kg	W
FT 01339	Ftool interface plate 146 x 56 x 12 mm	1 piece	1.30 kg	W
FT 01343	Ftool Interface uniplate for vise 20VL24	1 piece	0.22 kg	W

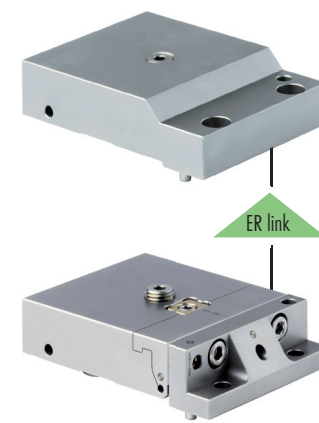

F-Tool interfaces EROWA

The practical and economic F-Tool frame pallets and vises can be inserted in the EROWA palletset W as well. It must be pointed out, that pin and excentric in the palletset W holder have to be removed on this application.

Article no.	Article	Quantity	Weight	Code
FT 01046	Ftool basic WEDM fix holder palletset W	1 piece	3.10 kg	B
FT 01047	Ftool basic WEDM pendulum holder palletset W	1 piece	3.25 kg	B
Options:				
FT 01318	Ftool vise 55F18	1 piece	1.07 kg	W
FT 01319	Ftool vise 100F22	1 piece	1.43 kg	W
FT 01358	Ftool spacer plate 100 x 29 x H 4 mm	1 piece	0.11 kg	W
FT 01360	Ftool frame pallet 100 x 22 mm	1 piece	3.28 kg	W
FT 01361	Ftool universal pallet 22 mm	1 piece	3.80 kg	W
FT 01362	Ftool blank pallet 22 mm	1 piece	2.75 kg	W
FT 01363	RefTool IF pallet 14 mm	1 piece	1.34 kg	W
FT 01448	Ftool Spacer plate 100 x 29 x H 12 mm	1 piece	0.31 kg	W
FT 01573	Ftool frame pallet 75 x 75 x 10 mm without clamping beam	1 piece	0.85 kg	W
FT 01574	Ftool frame pallet 135 x 75 x 10 mm without clamping beam	1 piece	1.50 kg	W



F-Tool ICS adapter

With the F-Tool ICS adapter, available ICS clamping elements can be received, respectively continued to use in the F-Tool basic rulers.

Article no.	Article	Quantity	Weight	Code
FT 02033	Ftool ICS Adapter 22	1 piece	0.48 kg	W
FT 02034	Ftool ICS Adapter 12	1 piece	0.32 kg	W

Combination examples:



F-Tool frame set link

The frame set link contains clamping elements, which can also be inserted in combination with the ER frame set.

F-Tool beams

The beams are accurate grinded and consist of hardened, corrosion-resistant, alloyed high-grade steel. The beams are furnished with clamping lips for the work piece clamping on one side and on the other side they can be clamped frontal. With the spacer plates 3 mm (FT 01070) the 3 mm high clamping lip can be lifted over the collision zone.

On the beams without Z-support you can assemble the Z-discs (FT 01911) and the Z-0 base plate (FT 01906).

A beam set consists of: 1 x beam / 2 x FT 01439 spacer plate 60 x 20 x 3 mm / 2 x FT 01441 countersunk screw corrosion-resistant, M8 x 25 / 2 x FT 01377 slide disc

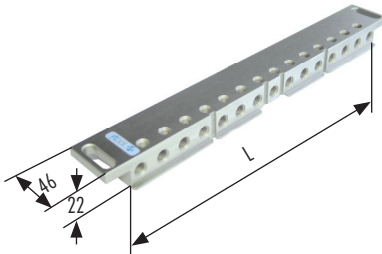

Article no.	Article	Quantity	Weight	Code
FT 01327	FTool beam L = 220 mm with clamping lips	1 piece	1.62 kg	W
FT 01063	FTool beam L = 300 mm with clamping lips	1 piece	1.97 kg	W
FT 01064	FTool beam L = 380 mm with clamping lips	1 piece	2.70 kg	W
FT 01065	FTool beam L = 460 mm with clamping lips	1 piece	3.20 kg	W
FT 01826	FTool beam L = 300/H25 mm without clamping lip	1 piece	2.19 kg	W
FT 01827	FTool beam L = 380/H25 mm without clamping lip	1 piece	2.74 kg	W
FT 01828	FTool beam L = 460/H36 mm without clamping lip	1 piece	5.73 kg	W
FT 02121	FTool clamping beam enforcement 380 / 460 x 36 x 8 mm	1 piece	0.90 kg	W



FT 02121



FT 02121

F-Tool beam IF

With the combination of F-Tool beam interfaces, span lengths in 5 mm steps, from 70 mm to 170 mm can be bridged. The FT beams can be assembled sideways or lengthwise. At the insertion of the F-Tool basic ruler, the required bridging width calculates as follows:

Hole distance assembling basic ruler (A) -20 mm -clamping beam length (L) = IF length total (C)

Example: RFI2050 A 320 -20 -L 220 = C 80 this corresponds the IF length C 1 / 35 mm and C 2 / 45 mm
 AQ537L A 470 -20 -L 300 = C 150 this corresponds 2 x IF lengths C 1 / C 2 = 75 mm
 or
 AQ537L A 470 -20 -L 380 = C 70 this corresponds 2 x IF lengths C 1 / C 2 = 35 mm

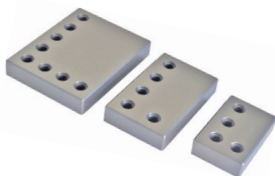

Article no.	Article	Quantity	Weight	Code
FT 01568	FTool beam IF 14/35/55 mm	1 piece	0.24 kg	W
FT 01569	FTool beam IF 14/45/75 mm	1 piece	0.41 kg	W
FT 01570	FTool beam IF 14/65/85 mm	1 piece	0.61 kg	W
FT 01825	FTool beam IF 14/65/95 mm	1 piece	0.68 kg	W

Combination examples:

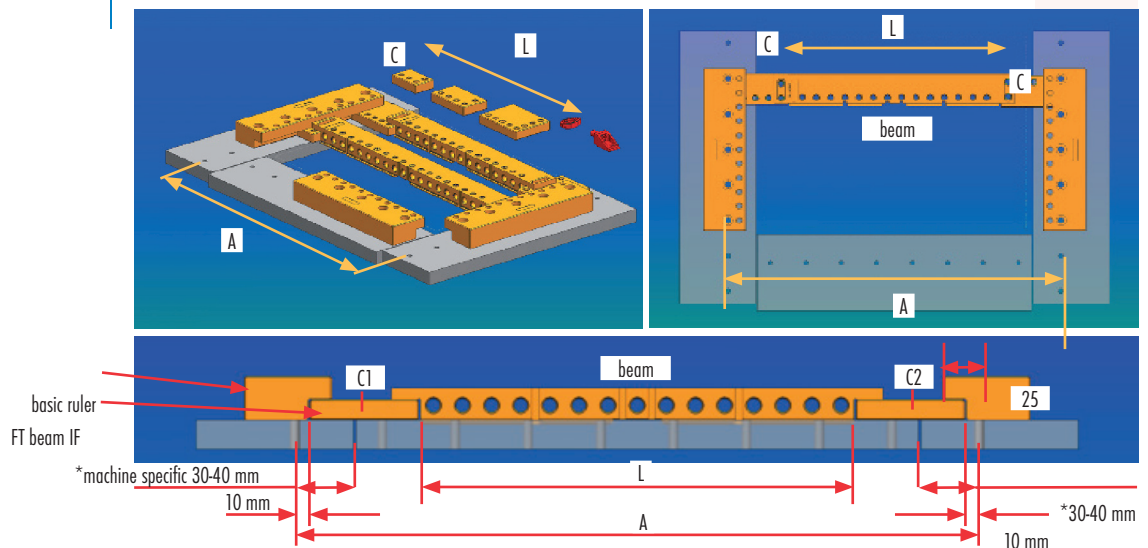



F-Tool DiaFix

As a support or clamping support plate of large, round work pieces. Frontal assembled, the DiaFix can be inserted into the clamping beams, the front spanner (FT 01350) and the Z-Flex support (FT 01760).

The set contains: 3 x support plate with the appropriate clamping appliances

Article no.	Article	Quantity	Weight	Code
FT 01879	FTool DiaFix F	Set of 3 pieces	1.30 kg	B

DiaFix F clamped in the Z-Flex support (FT 01760)

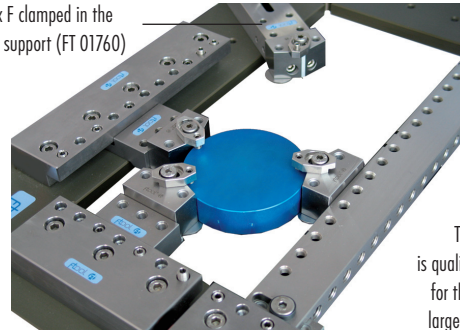

The DiaFix F-set is qualified especially for the clamping of large, round pieces.

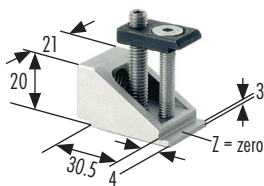

F-Tool distance support mini

For the clamping of small work pieces, respective thin plates. Can be inserted into the clamping beam, into the front spanner (FT 01350) or into the front spanner 140 x 30 x 35 mm (FT 01572).

Article no.	Article	Quantity	Weight	Code
FT 01066	FTool distance support mini	1 piece	0.18 kg	B

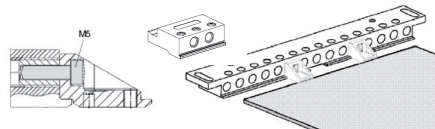

FT 01839



F-Tool beamwise single

Variable vise with a flexible and a stop jaw for the assembling on the F-Tool beams with support plates. Hardened, grinded, rust-resistant.

Article no.	Article	Quantity	Weight	Code
FT 01839	FTool Beamwise single 100 mm	1 piece	0.66 kg	W

Combination example:



FT 01840



F-Tool beamwise twin

Variable vise with two flexible and a stop jaw with double-sided support plate. For the assembling on the F-Tool beams. Hardened, grinded, rust-resistant.

Article no.	Article	Quantity	Weight	Code
FT 01840	FTool Beamwise twin 2 x 100 mm	1 piece	0.87 kg	W

FT 01593

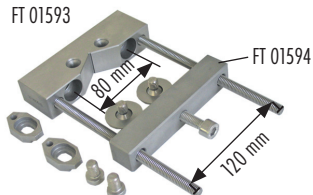

F-Tool prism holder 110 mm

The prism holder can be assembled frontal in the cross-holes of the beams (FT 01327 / FT 01063 - 65) and in the front spanner (FT 01572). The yoke (FT 01594) can be used directly on the beams and on the front spanner to clamp square pieces as well.

Article no.	Article	Quantity	Weight	Code
FT 01593	FTool prism holder 110 mm complete	1 piece	1.50 kg	W
FT 01594	FTool yoke 140 mm without prism holder	1 piece	0.65 kg	W

Combination examples:

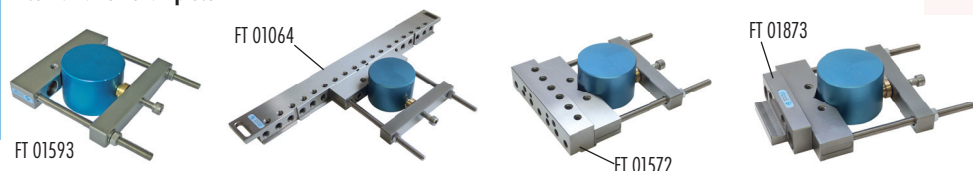

F-Tool Z-Flex and Z-Flex support



F-Tool Z-Flex

The Z-Flex could be clamped frontal in all clamping beams with cross holes Ø M10, distance 20 mm, or in the front spanners FT 01350 and FT 01572. With the Z-Flex you could adjust the supporting surface in state of the clamped work piece on 0.2 mm. Appropriate for the levelling of plates and work pieces. Delivered without brackets and allen key.

Article no.	Article	Quantity	Weight	Code
FT 01600	FTool Z-Flex	1 piece	0.36 kg	W



F-Tool Z-Flex support

The Z-Flex support is ideal for the support of big plates. He can be clamped directly of the machine table. This plates can be levelled after the clamping in combination with the Z-Flex (FT. The Z-Flex can be assembled on the front, right or left side of the Z-Flex support.

Dimensions: L = 170 / B = 46 / H = 27 mm

Article no.	Article	Quantity	Weight	Code
FT 01760	FTool Z-Flex support (without Z-Flex)	1 piece	1.60 kg	W

Delivered incl. brackets, Z-disc and miscellaneous screw material.

Combination examples:

F-Tool Z-Flex

- Ⓐ = adjusting screw Z-
- Ⓑ = adjusting screw Z+
- Ⓒ = fixing holes
- Ⓓ = clamping bracket holes
- Ⓔ = clamping lip
- Ⓕ = fixing screw
- Ⓖ = exposing-slot

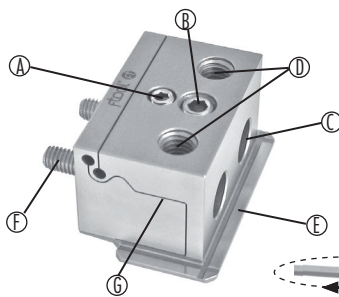

F-Tool Z-Flex support

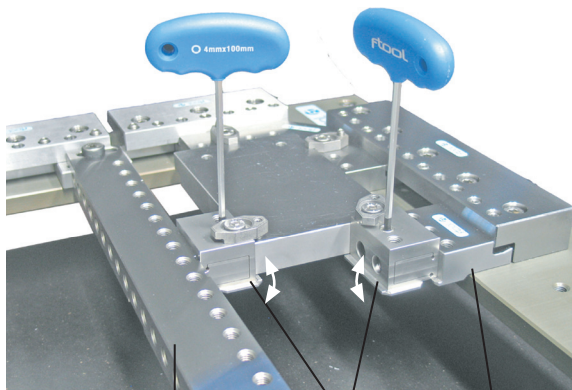
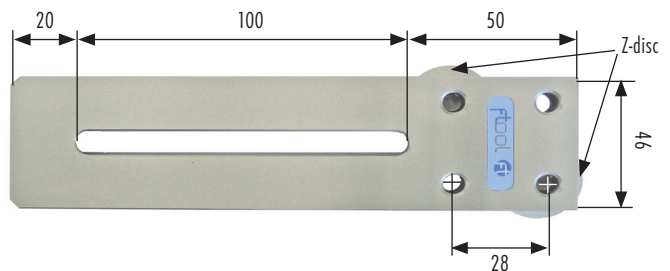

FT 01063-65 / FT 01327

FT 01600

FT 01350

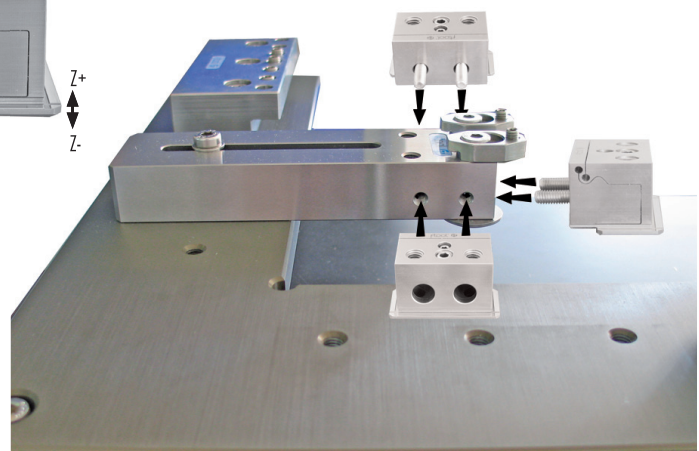

The F-Tool Z-Flex (FT 01600) can be assembled on the front, the left and the right side of the Z-Flex support (FT 01760).

F-Tool turn and index table

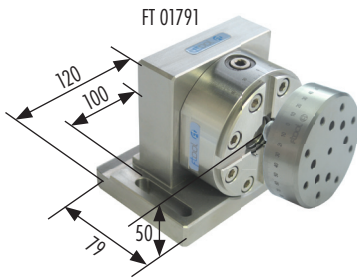

F-Tool WEDM square block-index-table

The F-Tool center chuck with spring-steel centering, 90° raster-indexation or stageless indexation with graduation. Able for the direct application on the drilling machine, on the WEDM-machine table with hole pattern 50 mm or to clamp with the F-Tool basic rulers (arbour height 50 mm). Delivered with a universal index adapter plate 80 with graduation (FT 01792) to adapt the ER chuck 80P (FT 01043), chuck 80 IF3R (FT 01044), collet chuck holder (FT 01580/FT 01581), electrodes or working pieces.

Dimension: 120 x 79 x 92 mm / Spindle height 50 mm

Article no.	Article	Quantity	Weight	Code
FT 01791	FTool WEDM square block-index-table 80, corrosion-resistant	1 piece	2.50 kg	W

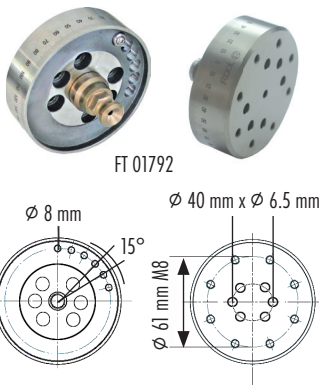

F-Tool universal index adapter plate

Universal adapter plate 80 with nonius-display to adapt the ER chuck 80P (FT 01043), chuck 80 IF3R (FT 01044), collet chuck holder (FT 01580/FT 01581), electrodes or working pieces.

Hole pattern: 8 x M8 reference circle 61 for ER chuck 80P & chuck 80 IF3R

For 6 x M6 circle diameter 40 mm (to adapt collet chuck holder, front spanner FT 01572 or electrodes respective working pieces)

Article no.	Article	Quantity	Weight	Code
FT 01792	FTool universal index adapter plate 80 with graduation, corrosion-resistant	1 piece	0.90 kg	W
FT 01430	FTool PIN index Ø 8/7 mm M5, corrosion-resistant	1 piece	0.01 kg	P
FT 01745	FTool PIN index Ø 8/7 mm M5, corrosion-resistant, hardened & ground	1 piece	0.01 kg	P

→ Delivered with RefPIN HP Z (FT 01719) and PIN index (FT 01430)



F-Tool collet chuck holder

Collet chuck holder with clamping nut for collet chucks ETS 32.

The collet chuck holder is corrosion-resistant and under careful care he could be also inserted in the water.

Article no.	Article	Quantity	Weight	Code
FT 01793	Collet chuck holder ETS32 incl. index adapter plate 80	1 piece	1.40 kg	W
FT 01581	FTool collet chuck holder ETS32 without adapter plate (corrosion-resist.)	1 piece	0.45 kg	A



Rustless, precision three-jawed chuck

Suitable for the application on EDM wire cutting machines under water. Hardened clamping jaws for the clamping of outside diameter Ø 1 - Ø 60 mm and inside diameter of Ø 12 - Ø 66 mm. Hole pattern 4 x M6, reference circle 40 mm.

Clamping accuracy ± 0.01 mm, maximum work piece weight: 2 kg

Article no.	Article	Quantity	Weight	Code
FT 02008	3 Jaw scroll chuck DBF63 rustless 0-56 mm Ø 70 mm L = 40 mm	1 piece	0.76 kg	P
FT 02053	3 Jaw scroll chuck DBF63 rustless with exchangeable soft jaws	1 piece	0.72 kg	P

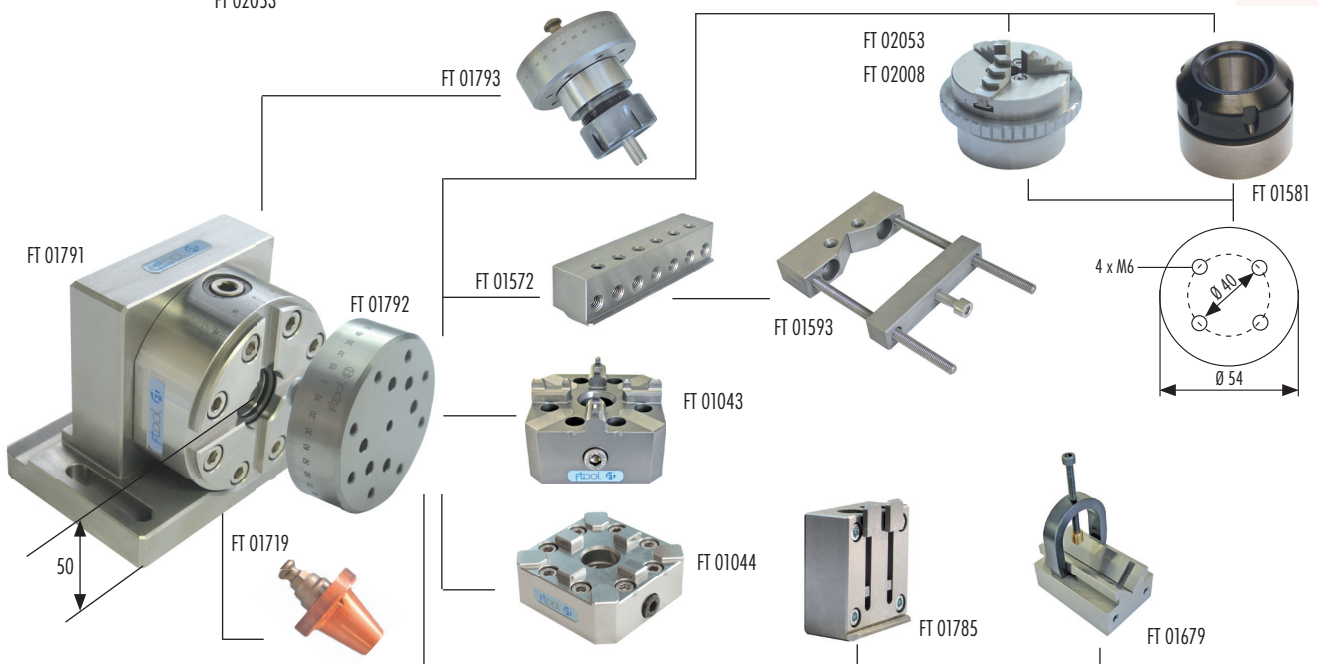



F-Tool ER-Chuck 50

ITS chuck system size 50, manual, corrosion-resistant. Fixing with 4 x M8, hole pattern 44 mm, from back side or with 4 x M6 with stud bolts and screw nut. Use on EDM / WEDM machines and for milling and grinding jobs.
Maximum rotation speed on rotating axes 200 U/min. Clamping force 4000 N

Article no.	Article	Quantity	Weight	Code
FT 02110	FTool ER-Chuck 50	1 piece	0.72 kg	B

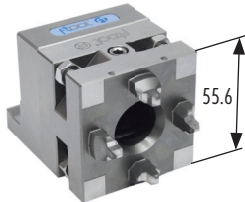

F-Tool ER-Chuck 50 assembled on WEDM angle

ER-Chuck 50 (FT 02110) assembled on WEDM angle (FT 01337) for the fast clamping with the F-Tool basic ruler.
Arbor height: 28 mm

Article no.	Article	Quantity	Weight	Code
FT 01333	FTool ER-Chuck 50 with WEDM IF angle QC50	1 piece	1.30 kg	B

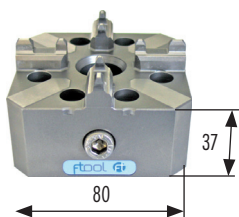

F-Tool ER chuck 80P

New, manual chuck. Corrosion-resistant. For the system sizes ER 50 and 100. Grinded flanks for the power centration. Strong, floating gripping mechanism.
Clamping force by hand with allen key: 5'000 - 8'000 N

Article no.	Article	Quantity	Weight	Code
FT 01043	FTool ER chuck 80P	1 piece	1.60 kg	A

→ Delivered with miscellaneous screw material and allen key

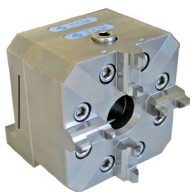

F-Tool ER chuck 80P assembled on WEDM angle

ER chuck 80P (FT 01043) assembled on WEDM angle (FT 01338). For the fast clamping with the F-Tool stop beads (basic ruler).
Arbor height: 40 mm

Article no.	Article	Quantity	Weight	Code
FT 01334	FTool ER chuck 80P with WEDM IF angle 80	1 piece	2.80 kg	W

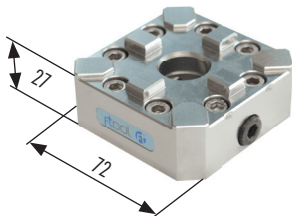

F-Tool chuck 80 IF3R

Manual made by F-Tool for 3R collet. Stainless. Strong, floating gripping mechanism.
Clamping force by hand with allen key: 5'000 - 8'000 N

Article no.	Article	Quantity	Weight	Code
FT 01044	FTool chuck 80 IF3R	1 piece	0.93 kg	A

→ Delivered with miscellaneous screw material and allen key



F-Tool chuck 80 IF3R assembled on WEDM angle

Chuck 80 IF3R (FT 01044) assembled on WEDM angle (FT 01338). For the fast clamping on the F-Tool stop beads (basic ruler).
Arbor height: 40 mm

Article no.	Article	Quantity	Weight	Code
FT 01335	FTool chuck 80 IF3R with WEDM IF angle 80	1 piece	2.10 kg	W

→ Delivered with miscellaneous screw material and allen key



F-Tool table set on 3R basis

Those table sets are for the upgrade of older machines with 3R dove tails.

Article no.	Article	Quantity	Weight	Code
FT 01907	WEDM table set on 3R base 350 x 105 x 30 mm (RFI200)	1 piece	5.85 kg	W
FT 01908	WEDM table set on 3R base 250 x 105 x 30 mm (RFI100)	1 piece		W

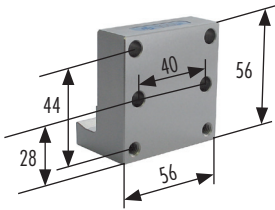

F-Tool WEDM angle QC50

For the collet of the quickchuck 50, the interface plate 146 x 56 x 12 mm or other appliances. The WEDM angle can be clamped directly in the F-Tool basic ruler. Delivered with miscellaneous screw material.

Arbor height from basis zero level (mid angle): 28 mm

Article no.	Article	Quantity	Weight	Code
FT 01337	FTool WEDM IF angle QC50	1 piece	0.61 kg	W

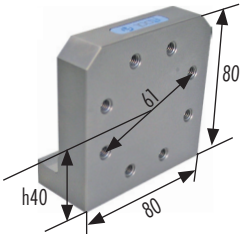

F-Tool WEDM angle IF 80

For the clamping of the ER/chuck 80 IF3R and other appliances. The WEDM angle can be clamped directly in the F-Tool basic ruler.

Arbor height from basis zero level (mid angle): 40 mm

Article no.	Article	Quantity	Weight	Code
FT 01338	FTool WEDM IF angle ITS/chuck 80 IF3R	1 piece	1.08 kg	W



F-Tool adapter plates palletset W

Adapter plates for the clamping of the magnetic table (FT 01326) and the vise 80VL50 (FT 01320) in the palletSet W-holder. For this application you need both plates.

Article no.	Article	Quantity	Weight	Code
FT 01842	FTool adapter plate palletset W	1 piece	0.98 kg	W
FT 01843	FTool IF plate PW90°	1 piece	0.70 kg	W

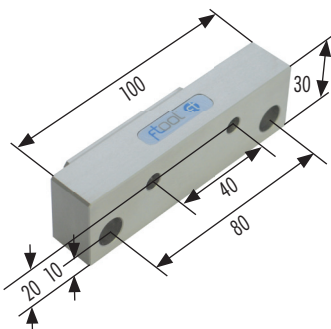

F-Tool basic ruler IF100/30

The basic ruler IF100/30 adapter is suited for the collet of the several beams, the front spanner 140 (FT 01572) or other installations directly into the ruler set (FT 01344).

Article no.	Article	Quantity	Weight	Code
FT 01873	Basic Ruler IF100/30	1 piece	0.55 kg	W

Combination example:

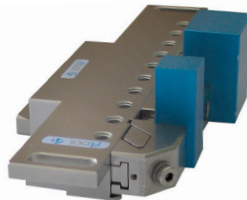

FT 01873 with beam 220 mm with clamping lips (FT 01327) and beamwise twin (FT 01057)

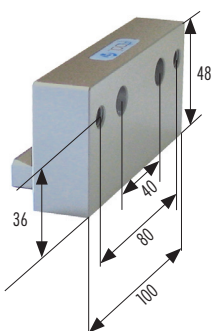

F-Tool basic ruler IF100/50

The basic ruler IF100/50 is suited for the clamping of the PIN MultiClamps 105 (FT 01809 + 01810), PIN MultiClamp 181 (FT 01811), MC railer 320 (FT 01882) or other installations directly into the ruler set (FT 01344).

Article no.	Article	Quantity	Weight	Code
FT 01878	Basic Ruler IF100/50	1 piece	0.84 kg	W

Combination examples:

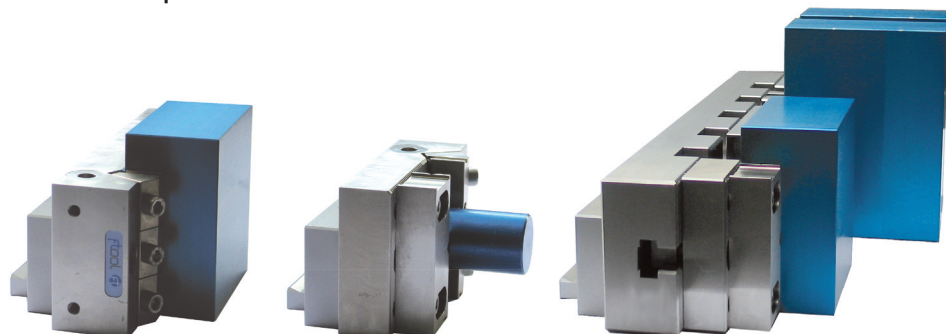

FT 01878 with PIN MultiClamp 181 (FT 01811)

FT 01878 with PIN MultiClamp 105 (FT 01809)

FT 01878 with MC railer 320 mm (FT 01882) and 2 x PIN MultiClamp 105 (FT 01809)

Pendulum head for EROWA UnoSet interface

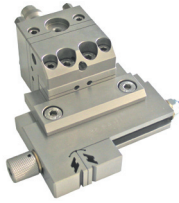

F-Tool ER swivel 55F18

ER pendulum head with vise 55F18. Adjustable in all three axes. Appropriate for the use on WEDM machines in the quickchuck 50 (arbor height 28 mm) or in the ER chuck 80P (arbor height 40 mm).

Article no.	Article	Quantity	Weight	Code
FT 01365	FTool ER swivel with FT vise 55F18	1 piece	2.30 kg	W

→ Delivered with chucking spigot (FT 01060), miscellaneous screw material and allen keys



F-Tool ER swivel 20VL24

ER pendulum head with vise 20VL24. Adjustable in all three axes. Appropriate for the use on WEDM machines in the quickchuck 50 (arbor height 28 mm) or in the ER chuck 80P (arbor height 40 mm).

Article no.	Article	Quantity	Weight	Code
FT 01364	FTool ER swivel with FT vise 20VL24	1 piece	2.00 kg	W

→ Delivered with chucking spigot (FT 01060), miscellaneous screw material and allen keys

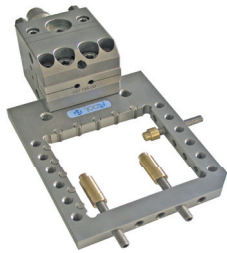

F-Tool ER swivel with frame pallet

ER pendulum head with frame pallet 75 mm. Adjustable in all three axes. Appropriate for the use on WEDM machines in the quickchuck 50 (arbor height 28 mm) or in the ER chuck 80P (arbor height 40 mm).

Article no.	Article	Quantity	Weight	Code
FT 01445	FTool ER swivel with frame pallet 75 x 75 x 10 mm	1 piece	2.00 kg	W

→ Delivered with chucking spigot (FT 01060), miscellaneous screw material and brass jacks

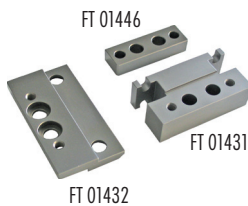

F-Tool ER swivel interfaces

The ER swivel interfaces are used to bring the appropriate clamping elements to the zero-height on the machine table. Therewith, the backside of the ER pendulum head can be combined with several clamping elements.

Article no.	Article	Quantity	Weight	Code
FT 01432	FTool ER swivel IF for vise 55F18	1 piece	0.26 kg	W
FT 01431	FTool ER swivel IF for vise 20VL24	1 piece	0.38 kg	W
FT 01446	FTool ER swivel IF 55 x 18 x 12 mm for frame pallet 75 x 75 x 10 mm	1 piece	0.12 kg	W



F-Tool ER adapter

This adapter plate is overwinded parallel in the system and provides an insertion of electrodes, work pieces and appliances. Corrosion-resistant.

Hole distance with 2 x M6 screws: 40 mm

Article no.	Article	Quantity	Weight	Code
FT 01435	FTool ER-plate EWIS	Set of 10 pieces	4.50 kg	A



F-Tool chucking spigot

Corrosion-resistant chucking spigots for the use in ER chucks on wire EDM machines.

Article no.	Article	Quantity	Weight	Code
FT 01060	FTool ER chucking spigot F/A WEDM	Set of 10 pieces	0.80 kg	B

F-Tool PreSet WT

F-Tool PreSet WT

Precision grinded granit table 500 x 315 x 90/60 mm, Quality 0, with grinded stopper h25 mm and 6 inlaid thread socket M8, Distance 50 mm.

To control, align and preset of work pieces, installed in miscellaneous F-Tool clamping elements.

1 x FT 02119 granite table
1 x FT 01347 basic ruler 140mm
1 x FT 01900 tripod FISSO STRATO M28

1 x FT 01901 mesuring clock 0.002
1 x FT 01403 FTool allen key with hand grip 4 mm
miscellaneous screws and keys

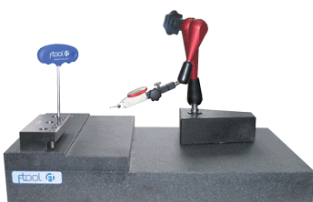

Article no.	Article	Quantity	Weight	Code
FT 02122	FTool PreSet WT 500 x 315 90/60	1 piece	47.00 kg	B

FT 01439

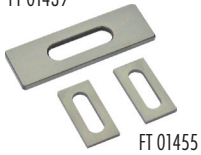

FT 01455

F-Tool beam spacer plates

The spacer plate 60/3 mm can be used for the lifting of 3 mm of the clamping beams, the front spanners or the side spanners. The spacer plate 28/2 mm is intended for the lifting of the clamping beam 75 mm (FT 01414) of the frame pallet 10 mm. To protect against collision of the clamping lips and flushing nozzles on machines with closed, no flexible flushing nozzles.

Article no.	Article	Quantity	Weight	Code
FT 01439	Ftool spacer plate 60 x 20 x 3 mm for beam	Set of 2 pieces	0.04 kg	W
FT 01455	Ftool spacer plate 28 x 14 x 2 mm for beam 75 mm	Set of 2 pieces	0.01 kg	W

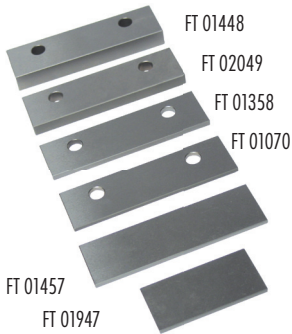

FT 01448

FT 02049

FT 01358

FT 01070

FT 01457

FT 01947

F-Tool spacer plates

For the assembling of miscellaneous clamping elements in the swivel table IF 22 (FT 01355) or in the palletset W adapter to basis zero. Basis height: 22 mm - height clamping element = height spacer plate

The spacer plate H 3 mm (FT 01070) can be used as well for the lifting of the F-Tool clamping elements with clamping lips. To protect against collision of the clamping lips and flushing nozzles on machines with closed, no flexible flushing nozzles.

Article no.	Article	Quantity	Weight	Code
FT 01070	Ftool spacer plate 100 x 29 x H 3 mm	1 piece	0.09 kg	W
FT 01358	Ftool spacer plate 100 x 29 x H 4 mm	1 piece	0.11 kg	W
FT 01448	Ftool spacer plate 100 x 29 x H 12 mm	1 piece	0.31 kg	W
FT 01457	Ftool spacer plate 100 x 29 x H 3 mm	1 piece	0.09 kg	W
FT 01947	Ftool spacer plate 60 x 29 x H 3 mm	1 piece	0.04 kg	W
FT 02049	Ftool spacer plate 100 x 29 x H 8 mm	1 piece	0.17 kg	W



F-Tool clamping beam for frame pallet

Small, accurate, corrosion-resistant clamping beams for the frame pallet 10 mm. Provided with 2 mm lips on both sides. On one side, equipped with a compact strip for work pieces of < 10 mm height. On the other side with exemption for the clamping of high work pieces. Delivered completely with screws.

Article no.	Article	Quantity	Weight	Code
FT 01414	Ftool clamping beam 75 mm two-sided for frame pallet 10 mm	1 piece	0.23 kg	W

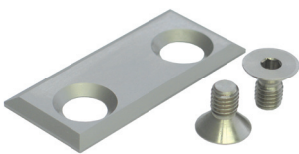

F-Tool Z-plate

The Z-0 base plate, made of corrosion-resistant, grinded steel, can be assembled on beams without clamping lips. Depending on the direction, respective the clamping function, the lip overlap 4 mm or 9 mm from the support.

Article no.	Article	Quantity	Weight	Code
FT 01906	Z-0 base plate 4/9 mm 69 x 31 x 3.4 mm	1 piece	0.10 kg	W

Combination example:

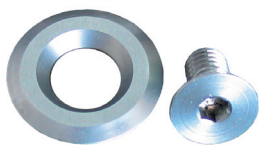
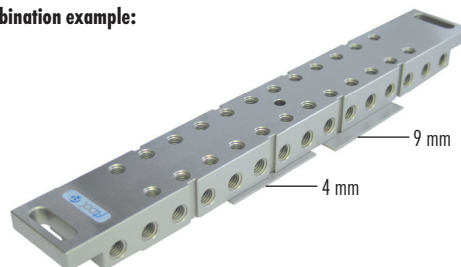

F-Tool Z-plate

The Z-0 base plate, made of corrosion-resistant, grinded steel, can be assembled on beams without clamping lips or other clamping devices.

Article no.	Article	Quantity	Weight	Code
FT 01911	Z-disc 3 mm incl. countersunk screw M8 x 14 mm	1 Set	0.05 kg	B



F-Tool pressure screw

Pressure screw, corrosion-resistant with pressure surface and applicable pressure angle for the basic ruler.

Article no.	Article	Quantity	Weight	Code
FT 01373	Ftool pressure screw M8 x 18 mm	1 piece	0.01 kg	W



F-Tool stopper

Stopper hardened, corrosion-resistant, complete with special screw M6 x 16 mm. To fix on the basic ruler's.

Article no.	Article	Quantity	Weight	Code
FT 01376	Ftool stopper hardened with screw M6 corrosion-resistant	1 piece	0.01 kg	W

Accessories and spare parts

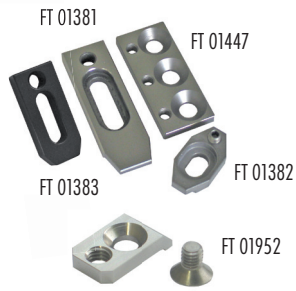

F-Tool brackets

Brackets corrosion-resistant for the miscellaneous clamping elements.

Article no.	Article	Quantity	Weight	Code
FT 01381	FTool bracket 70E103 corrosion-resistant	1 piece	0.07 kg	W
FT 01382	FTool bracket ER34 corrosion-resistant	1 piece	0.02 kg	W
FT 01383	FTool bracket ER45 corrosion-resistant	1 piece	0.08 kg	B
FT 01447	FTool multi bracket 60 x 26 x H6 mm corrosion-resistant	1 piece	0.06 kg	W
FT 01952	Mini Bracket 22 x 13 x 3.8 mm	1 piece	0.05 kg	W



F-Tool jacks

The jacks can be used as bracket supports or as screw extensions on the universal pallet and the miscellaneous frame pallets. The soft brass material prevents the marking on the work piece by the brackets and the screws.

Article no.	Article	Quantity	Weight	Code
FT 01322	FTool jack brass Ø 20 x 10 mm for M8	1 piece	0.02 kg	W
FT 01323	FTool jack extension brass Ø 20 x 20 mm	1 piece	0.05 kg	W
FT 01456	FTool jackset adjustable Ø 20 x 20-26 mm	1 piece	0.05 kg	W
FT 01492	FTool jack brass Ø 9.5 x 10 mm for M6	1 piece	0.01 kg	W
FT 01493	FTool jack extension brass Ø 9.5 x 20 mm	1 piece	0.01 kg	W



F-Tool allen keys

Allen keys with hand grip.

Article no.	Article	Quantity	Weight	Code
FT 01403	FTool allen key with hand grip 4 mm L = 100 mm	1 piece	0.01 kg	B
FT 01404	FTool allen key with hand grip 5 mm L = 150 mm	1 piece	0.02 kg	B
FT 01405	FTool allen key with hand grip 6 mm L = 150 mm	1 piece	0.03 kg	B

Tooling care products



TCE-Fluid 435 F-Tool corrosion protection

For care and conservation of the system parts. Dries immediately after application. It's qualified excellent for the protection of casting forms.

Article no.	Article	Quantity	Weight	Code
FT 01676	TCE-Fluid 435 FTool corrosion protection 500 ml	1 piece	0.50 kg	B



TCE-Fluid 010 F-Tool universal cleaner

Highly efficient spray cleaner. Cleans strong disposals on system parts and working pieces. Deep-pore cleaning.

Article no.	Article	Quantity	Weight	Code
FT 01677	TCE-Fluid 010 FTool universal cleaner 500 ml	1 piece	0.50 kg	B



F-Tool protection grease Caltima

For enduring grease of the guides, links, screws and threads in the water bath.

Article no.	Article	Quantity	Weight	Code
FT 01678	FTool protection grease Caltima	1 piece	0.45 kg	B

See for yourself. To meet your practical circumstances you are only one «click» away from us.

Visit our homepage at

www.f-tool.com

Head office:

F-Tool International AG • Oberdorf 6 • P.O. Box • CH-5040 Schöftland • Switzerland •
Phone +41 (0)62 739 00 30 • Fax +41 (0)62 739 00 39 • E-Mail: info@f-tool.com

Subsidiary in Germany:

F-Tool GmbH • Gewerbepark Breisgau • Freiburger Strasse 19 • DE-79427 Eschbach •
Phone +49 (0)7634 5048 83-0 • Fax +49 (0)7634 5048 83-15 • E-Mail: info@f-tool.de

Subsidiary in Thailand:

F-Tool (Thailand) Co., Ltd. • 12/3 Moo 10 • Klong-Khoi, Pak-Kred • TH-11120 Nonthaburi •
Phone +66 (0)84 757 66 62-3 • Fax +66 2571 3791 • E-Mail: ftoolth@ksc.th.com

Member of the EROWA Group

Technical modifications reserved.

For a number of products of F-Tool International AG, patents have been granted or are pending.