

F-Tool square clamp

The new dimension for EDMing.  
Simple, accurate and extremely economic.

1. The function

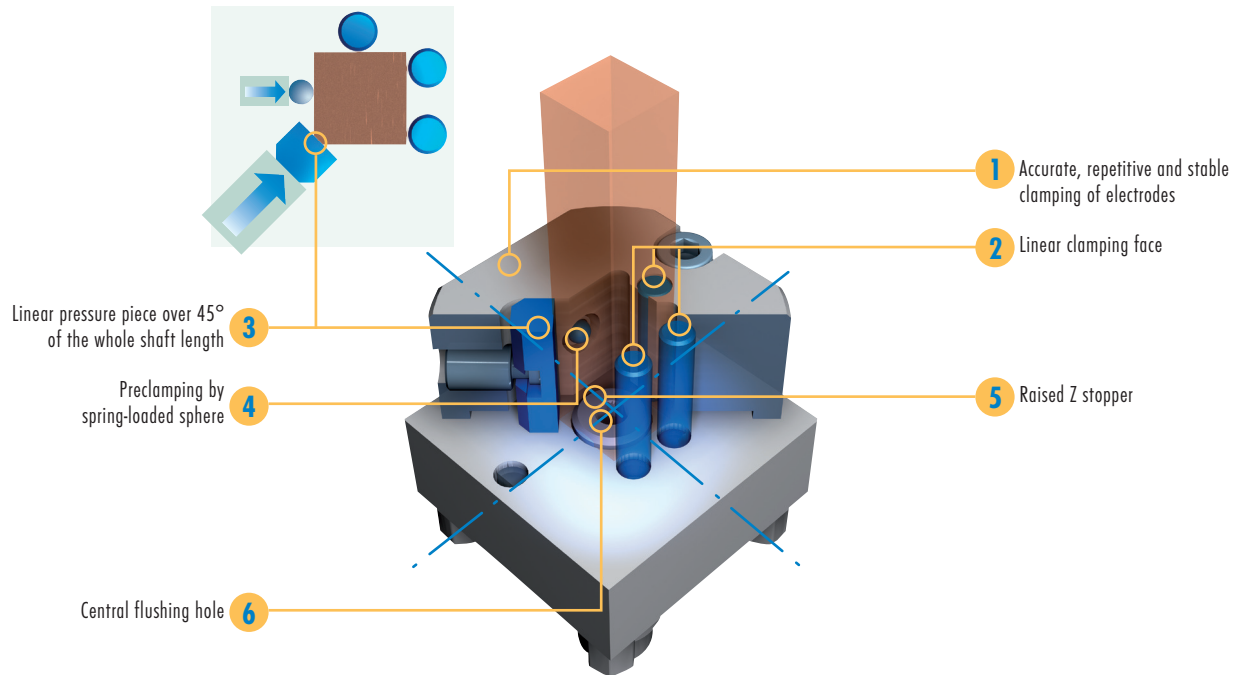

2. The application

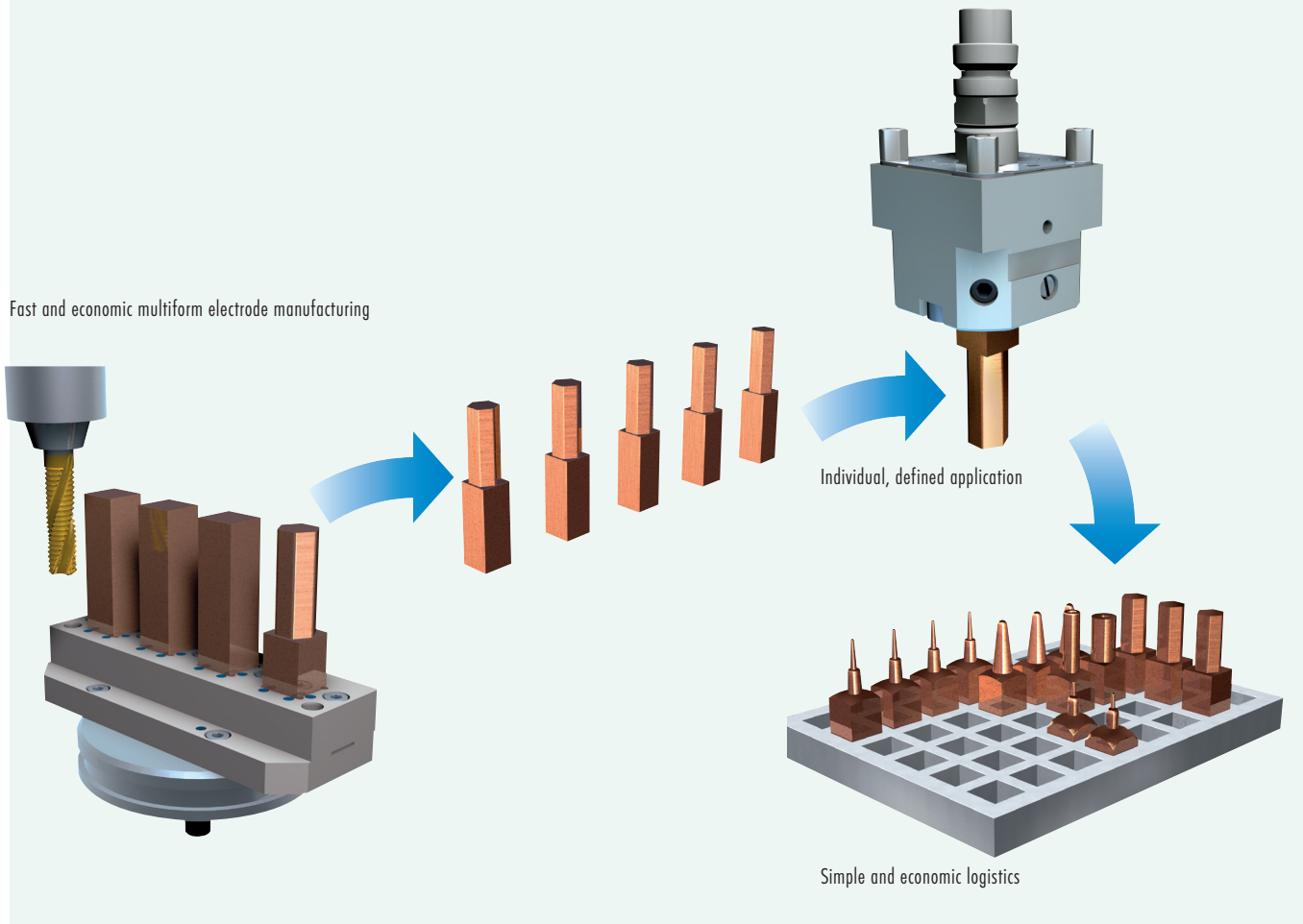

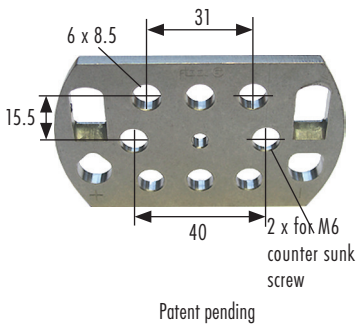

**RefTool graphite adapter**

The RefTool graphite adapter can be screwed, according to the hole pattern, with two or several M8 screws on a prepared graphite blank and can afterwards be handled reference based and system accurate.  
The RefTool adapters are very inexpensive and functional.  
→ Positioning / repeat accuracy < 0.01 mm

Article no.	Article	Quantity	Weight	Code
FT 01120	RefTool adapter with hole pattern	Set of 20 pieces	3.20 kg	A

**Delivered with 2 x M8 screws and 2 x M6 countersunk screws.**

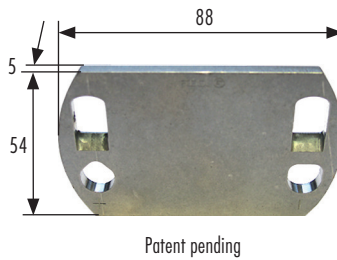

**RefTool WEDM adapter**

With the RefTool WEDM adapter copper plates, for example, can be tightened and with the cutting erosion machine through the plate be handled in reference position. In the next following step, the rough-worked electrodes can be removed from the cutting machine, followed up in the RefTool holder and without loss of time, inserted on the EDM machine in reference position.  
→ Positioning / repeat accuracy < 0.01 mm

Article no.	Article	Quantity	Weight	Code
FT 01121	RefTool adapter without hole pattern	Set of 20 pieces	3.10 kg	A

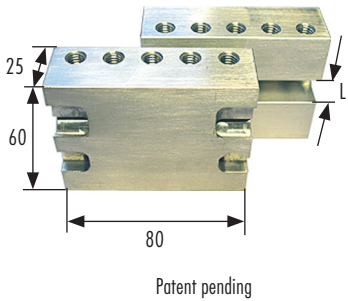

**RefTool graphite clamp (aluminium)**

The RefTool graphite clamp is uttermost inexpensive and perfect for the collet of graphite blanks.  
→ Tailor graphite → clamp → in a matter of seconds finished for the manufacturing process

Article no.	Article	Quantity	Weight	Code
FT 01124	RefTool graphite clamp L = 13 mm alu	Set of 16 pieces	4.60 kg	A
FT 01125	RefTool graphite clamp L = 26 mm alu	Set of 16 pieces	4.00 kg	A
FT 01126	RefTool graphite clamp L = 33 mm alu	Set of 16 pieces	3.72 kg	A
FT 01053	RefTool clamp mixed set, of 4 x L = 0 / 13 / 26 / 33 mm alu	Set of 16 pieces	4.40 kg	A

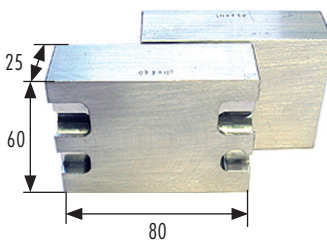

**RefTool free clamp (aluminium)**

The RefTool free clamp aluminium can be freely prepared for the different shapes of electrodes. It can also be prepared for special electrode shapes and can be cut by wire EDM machine.

Article no.	Article	Quantity	Weight	Code
FT 01052	RefTool free clamp alu	Set of 16 pieces	5.20 kg	A

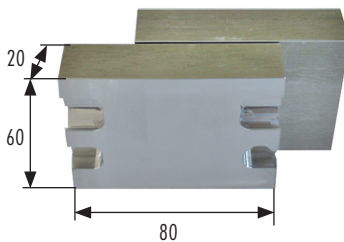

**RefTool free clamp (steel)**

The RefTool free clamp steel can be freely prepared for the different shapes of electrodes. It can also be prepared for special electrode shapes and can be cut by wire EDM machine.

Article no.	Article	Quantity	Weight	Code
FT 01221	RefTool free clamp steel	Set of 16 pieces	11.30 kg	A

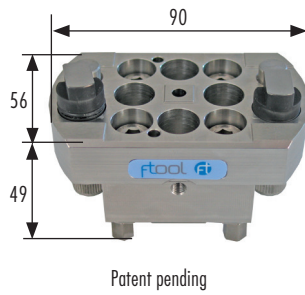

**RefTool holder with EROWA interface**

The RefTool holder is a new developed reference holder of F-Tool. The RefTool holder is suited mainly for the retaining of divers electrodes, particularly of inexpensive graphite collets.

The RefTool holder is assembled on the repeat accurate, premium, stainless high-grade steel-basis plate.

- Fast electrode clamping by adapted, standardised grandeur specifications (hole pattern or clamping nut)
- Uttermost inexpensive reference holders
- System accuracy of ITS (transfer from clamp to clamp) < 2 µm
- System accuracy of the reference holders < 0.01 mm (clamping / unclamping of the electrodes)

Article no.	Article	Quantity	Weight	Code
FT 01118	RefTool holder EWIS	1 piece	1.00 kg	A
FT 01119	RefTool holder EWIS	Set of 5 pieces	5.00 kg	A

Delivered without chucking spigot.

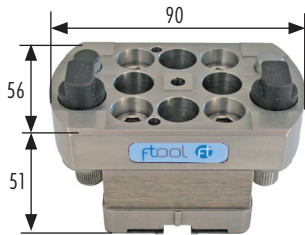

**RefTool holder with IF3R interface**

Equipped with reference element 3R. Compatible with 3R-MACRO.

Article no.	Article	Quantity	Weight	Code
FT 01141	RefTool holder IF3R (compatible with 3R)	1 piece	0.97 kg	A
FT 01142	RefTool holder IF3R (compatible with 3R)	Set of 5 pieces	5.20 kg	A

Delivered without spigot.

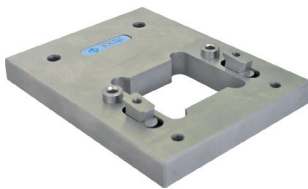

**RefTool IF pallet**

With the RefTool IF pallet, electrodes can be handled on the RefTool holders in reference position with the wire EDM machine. The RefTool IF pallet is delivered completely with screws and keys.

Pallet dimension: 130 x 100 x 14 mm

Article no.	Article	Quantity	Weight	Code
FT 01363	RefTool IF pallet 14 mm	1 piece	1.34 kg	W

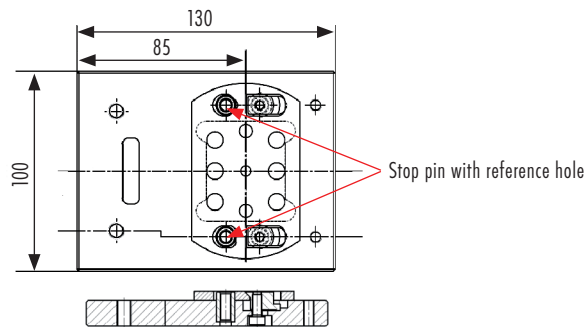

**RefTool setup**

With the RefTool setup, the RefTool adapters can be assembled and disassembled comfortable on the RefTool holders.

Article no.	Article	Quantity	Weight	Code
FT 01123	RefTool setup	1 piece	2.45 kg	A



**RefTool checking plate**

The RefTool holders undergo a severe check and are delivered system accurate ex works. After a crash or a long service it's worth to make a quality check with the RefTool checking plate.

Article no.	Article	Quantity	Weight	Code
FT 01122	RefTool checking plate (grinded and hardened)	1 piece	0.83 kg	A

The RefTool holder brings completely new possibilities to clamp electrodes fast and economic.

**1. The function**

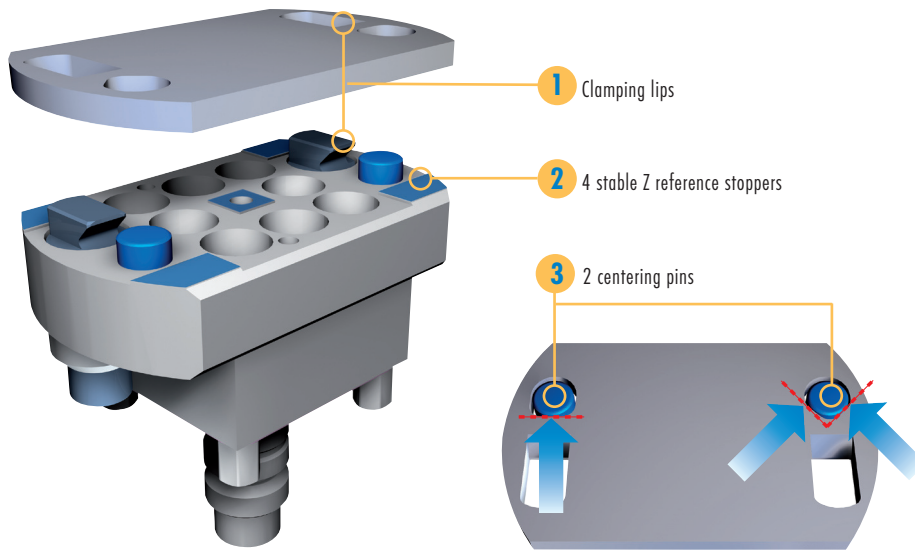

**2. Economic electrode holders**

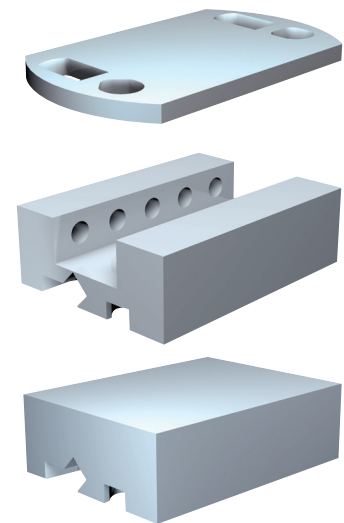

**3. The application**

**3.1. RefTool graphite adapter**

- Screw the RefTool graphite adapter on the graphite blank
- Cut and use the electrode in the system
- Store the electrodes together with the economic graphite adapter

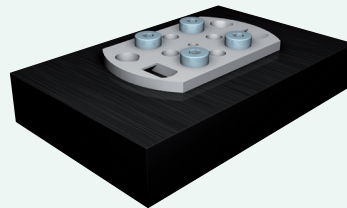

**3.2. RefTool graphite clamp**

- Clamp the graphite blank into the clamp
- Cut and use the electrode in the system
- Store the electrodes with the economic graphite clamp

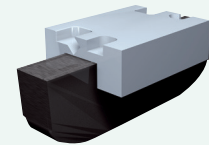

**3.3. RefTool WEDM adapter**

RefTool free clamp

- The electrode can be cut in reference position by wire EDM through the RefTool WEDM adapter or the free clamp

- Complex form electrode-cut by WEDM

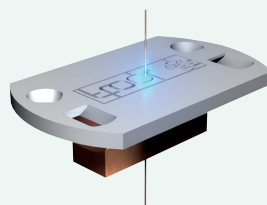

RefTool WEDM adapter

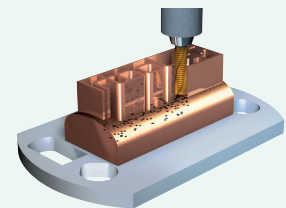
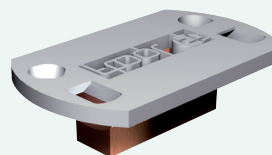

- Complex profiles for serial jobs cut by WEDM

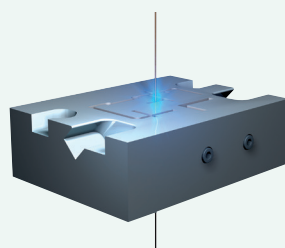

RefTool free clamp

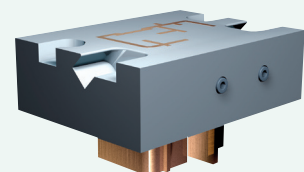
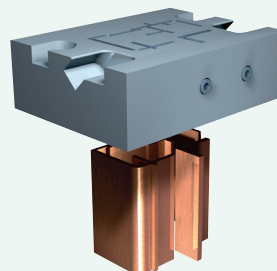

## The F-Tool UniClamp reduces the consumption of electrode material

Simply saw the graphite, clamp it into the UniClamp, machine and erode.

All F-Tool UniClamp are from A like alignment to Z like Z-support identical. Electrodes can be removed from the UniClamp and re-clamped in reference position. The short clamping height reduces the consumption of electrode material.

Less set-up time, less consumption of electrode material, less costs

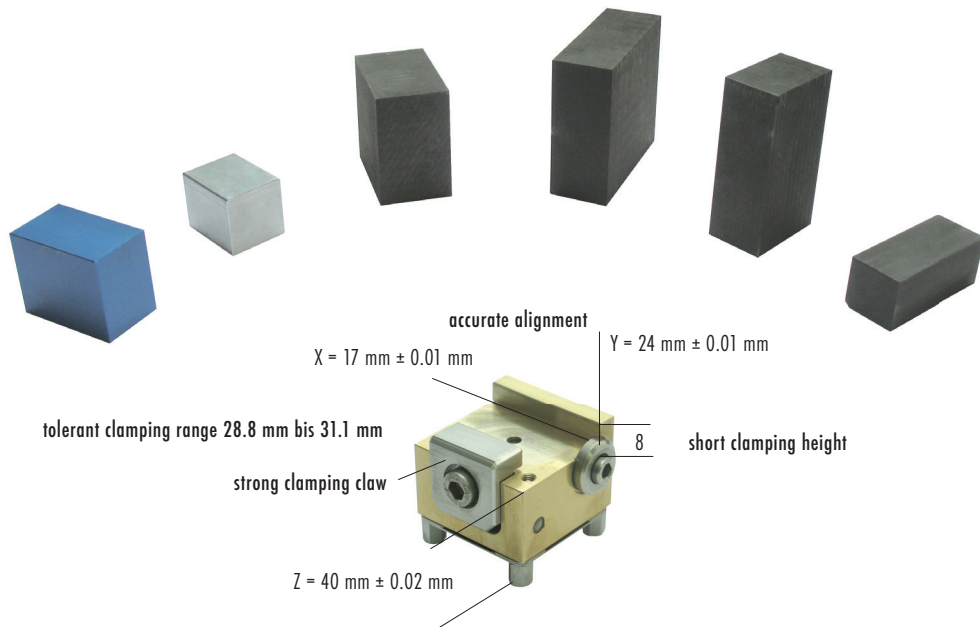

### F-Tool UniClamp

The F-Tool UniClamp are new, basically developed as electrode holders. The strong clamping claw pushes the electrode to the reference surface and holds it firmly in position. Electrode blanks can simply be sawed off and clamped quickly. Also completed electrodes can be clamped permanently on different UniClamp in reference position. The F-Tool UniClamp is suited as well for clamping and machining of precision parts.

Article no.	Article	Quantity	Weight	Code
FT 01953	FTool UniClamp ER-30	1 piece	0.72 kg	A
FT 01957	FTool UniClamp ER-30	Set of 10 pieces	6.84 kg	A



### F-Tool UniClamp TR30 (compatible with 3R)

The F-Tool UniClamp are new, basically developed as electrode holders. The strong clamping claw pushes the electrode to the reference surface and holds it firmly in position. Electrode blanks can simply be sawed off and clamped quickly. Also completed electrodes can be clamped permanently on different UniClamp in reference position. The F-Tool UniClamp is suited as well for clamping and machining of precision parts.

Article no.	Article	Quantity	Weight	Code
FT 01954	FTool UniClamp TR-30	1 piece	0.82 kg	A
FT 01958	FTool UniClamp TR-30	Set of 10 pieces	7.88 kg	A

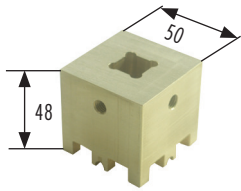

**Brass holder IF-H**

F-Tool brass holder for the collet of square blanks 15. Compatible with chucks of the system Hirschmann.

Article no.	Article	Quantity	Weight	Code
FT 01999	Square 15 Brass holder IF-H	Set of 10 pieces	7.77 kg	A

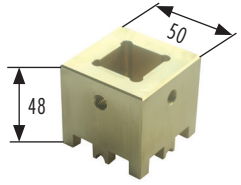

**Brass holder IF-H**

F-Tool brass holder for the collet of square blanks 25. Compatible with chucks of the system Hirschmann.

Article no.	Article	Quantity	Weight	Code
FT 02000	Square 25 Brass holder IF-H	Set of 10 pieces	6.90 kg	A

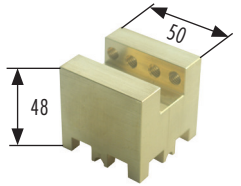

**Brass holder IF-H**

F-Tool brass holder for the collet of electrode blanks. Compatible with chucks of the system Hirschmann. Clamping width up to 20 mm.

Article no.	Article	Quantity	Weight	Code
FT 02001	UNI Brass holder 20 IF-H	Set of 10 pieces	7.08 kg	A

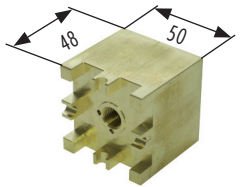

**Brass holder IF-H**

F-Tool brass holder for the collet of electrode blanks. Compatible with chucks of the system Hirschmann. The clamping form and size can be attached individually on the holder.

Article no.	Article	Quantity	Weight	Code
FT 02002	UNI-Blank Brass holder IF-H	Set of 10 pieces	8.80 kg	A

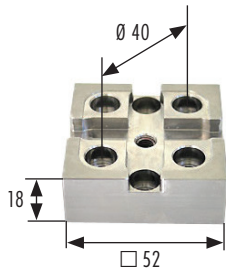

### F-Tool basic plate IF3R

The F-Tool basic plates IF3R made by F-Tool are standard adapters for miscellaneous collets or for the direct clamping of electrode blanks. The reference slot for the IF3R chucks is produced in high-precision.

Material: rustless steel

Hole pattern: 6 x Ø 6.5 mm on reference circle diameter 40 mm

Article no.	Article	Quantity	Weight	Code
FT 01135	FTool basic plate IF3R	Set of 10 pieces	3.30 kg	A

Delivered without spigots.

Recommended spigots, according to chuck: FT 01223 / FT 01224 / FT 01225

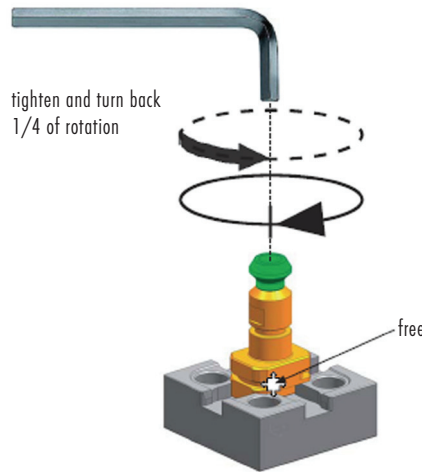

### Collet chuck holder with IF3R

Collet chuck holder ETS32, rust resistant, assembled with sealing washer on a F-Tool basic plate IF3R. Compatible with 3R-MACRO.

Article no.	Article	Quantity	Weight	Code
FT 01237	FTool collet chuck holder ETS32 / IF3R	1 piece	1.52 kg	A
FT 02017	Acorn nut M40 x 1.5 mm ETS32	1 piece		B

Delivered without chucking spigot. Collet chucks, see p. 21.

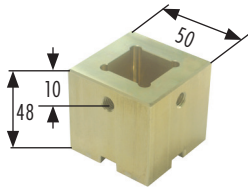

### Brass holder IF3R

F-Tool brass holder for the collet of square blanks 15. Compatible with chucks of the system 3R. The square collet was manufactured in reference position.

Article no.	Article	Quantity	Weight	Code
FT 01995	Square 15 Brass holder IF3R	Set of 10 pieces	8.50 kg	A

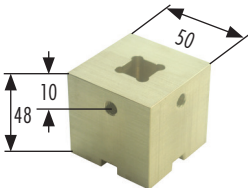

### Brass holder IF3R

F-Tool brass holder for the collet of square blanks 25. Compatible with chucks of the system 3R. The square collet was manufactured in reference position.

Article no.	Article	Quantity	Weight	Code
FT 01996	Square 25 Brass holder IF3R	Set of 10 pieces	7.40 kg	A

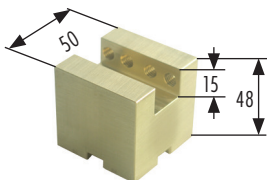

### Brass holder IF3R

F-Tool brass holder for the collet of electrode blanks. Compatible with chucks of the system 3R. Clamping width up to 20 mm.

Article no.	Article	Quantity	Weight	Code
FT 01997	UNI Brass holder 20 IF3R	Set of 10 pieces	7.90 kg	A

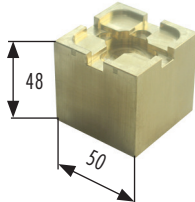

### Brass holder IF3R

F-Tool brass holder for the collet of electrode blanks. Compatible with chucks of the system 3R. The clamping form and size can be attached individually on the holder.

Article no.	Article	Quantity	Weight	Code
FT 01998	UNI-Blank Brass holder IF3R	Set of 10 pieces	9.32 kg	A



**F-Tool chuck 80 IF3R**

Manual chuck made by F-Tool for 3R collet. Stainless. Strong, floating gripping mechanism.  
Clamping force by hand with Allen key: 5'000 - 8'000 N

Article no.	Article	Quantity	Weight	Code
FT 01044	FTool chuck 80 IF3R	1 piece	0.93 kg	A

→ Delivered with miscellaneous screw material and Allen key



**EDM adapter plate** (details on page 3)

Article no.	Article	Quantity	Weight	Code
FT 01236	EDM adapter plate Ø 110 mm chuck 80/PIN chuck	1 piece	1.32 kg	A
FT 01829	EDM adapter plate Ø 110 mm without hole pattern Ø 96 mm	1 piece	1.32 kg	A



**Adapter plate** (details on page 3)

Article no.	Article	Quantity	Weight	Code
FT 01336	Adapter plate 120 x 82 mm chuck 80/PIN chuck	1 piece	1.40 kg	A



**Square block** (details on page 3)

Article no.	Article	Quantity	Weight	Code
FT 01483	Square block chuck 80/PIN chuck	1 piece	8.20 kg	A

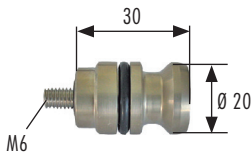

**F-Tool spigot 20 MS short M6 IF3R**

Version: Type Ø 20 short, M6 for helicoil in basic plate IF3R, rustless, the screw is provided with a central flushing hole.  
Application: For the manual application of F-Tool basic plates IF3R (FT 01135) in the F-Tool chuck 80 IF3R (FT 01044).

Article no.	Article	Quantity	Weight	Code
FT 01224	FTool spigot 20 MS short M6 IF3R	Set of 10 pieces	0.76 kg	A

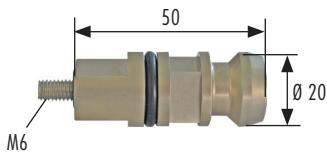

**F-Tool spigot 20 ATC long M6 IF3R**

Version: Type Ø 20 long, M6 for helicoil in basic plate IF3R, rustless, the screw is provided with a central flushing hole.  
Application: For the manual or automatic application of F-Tool basic plates IF3R (FT 01135) in the MACRO chuck.

Article no.	Article	Quantity	Weight	Code
FT 01223	FTool spigot 20 ATC long M6 IF3R	Set of 10 pieces	0.91 kg	A

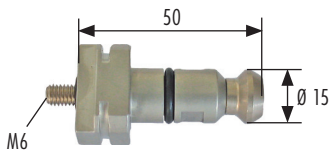

**F-Tool spigot 15 MC/ATC M6 IF3R**

Version: Type Ø 15, M6 for helicoil in basic plate IF3R, rustless, the screw is provided with a central flushing hole.  
Application: For the manual or automatic application of F-Tool basic plates IF3R (FT 01135) in the MACRO/Combi chuck.

Article no.	Article	Quantity	Weight	Code
FT 01225	FTool spigot 15 MC/ATC M6 IF3R (Macro/Combi)	Set of 10 pieces	1.00 kg	A

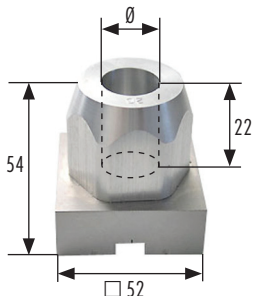

**F-Tool holder with basic plate IF3R**

Electrode holders, equipped with the rustless F-Tool IF3R high-grade steel interface plate made by F-Tool. Incl. aluminium insert for the shaft collet of miscellaneous diameters. Appropriate for clamping of copper and graphite blanks and for the high-precision machining of electrodes in the F-Tool chuck 80 IF3R (FT 01044) or MACRO chuck and for the following application on EDM machines.

Article no.	Article	Quantity	Weight	Code
FT 01136	FTool holder Ø 10 mm IF3R (compatible with 3R)	Set of 10 pieces	4.70 kg	A
FT 01137	FTool holder Ø 12 mm IF3R (compatible with 3R)	Set of 10 pieces	4.70 kg	A
FT 01138	FTool holder Ø 16 mm IF3R (compatible with 3R)	Set of 10 pieces	4.60 kg	A
FT 01139	FTool holder Ø 20 mm IF3R (compatible with 3R)	Set of 10 pieces	4.50 kg	A
FT 01317	FTool holder Ø 26 mm IF3R (compatible with 3R)	Set of 10 pieces	4.40 kg	A
FT 01140	FTool holder Ø 30 mm IF3R (compatible with 3R)	Set of 10 pieces	4.30 kg	A
FT 01226	FTool holder mixed set IF3R, of 2 x 10 / 12 / 16 / 20 / 26 mm	Set of 10 pieces	4.60 kg	A

Delivered without spigots.

Recommended spigots, according to chuck: FT 01223 / FT 01224 / FT 01225

## EROWA link Compact

### Compact Holder

Electrode holders for different diameters mounted on system EROWA compact.



Article no.	Article	Quantity	Weight	Code
FT 01181	Compact holder 8 mm	Set of 10 pieces	1.40 kg	A
FT 01182	Compact holder 10 mm	Set of 10 pieces	1.40 kg	A
FT 01183	Compact holder 12 mm	Set of 10 pieces	1.40 kg	A
FT 01184	Compact holder 16 mm	Set of 10 pieces	1.40 kg	A
FT 01185	Compact holder 20 mm	Set of 10 pieces	1.40 kg	A
FT 01235	Compact holder mixed set, of 2 x 8 / 10 / 12 / 16 / 20 mm	Set of 10 pieces	1.40 kg	A



### Compact slot holder

Electrode holder with slot mounted on system EROWA compact.

Article no.	Article	Quantity	Weight	Code
FT 01000	Compact slot 12 mm	Set of 10 pieces	1.90 kg	A



### Compact square

Square electrode holder mounted on system EROWA compact.

Article no.	Article	Quantity	Weight	Code
FT 01329	Compact square 10	1 piece	0.29 kg	A
FT 01330	Compact square 10	Set of 10 pieces	2.90 kg	A
FT 01054	Compact square 15	1 piece	0.40 kg	A
FT 01055	Compact square 15	Set of 10 pieces	3.60 kg	A

## Universal-Electrode holder

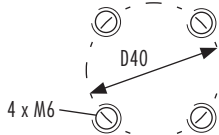
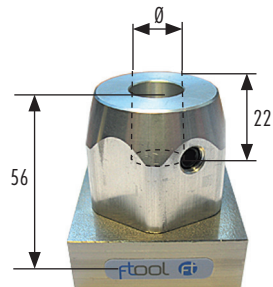

### F-Tool holder prepared for 3R-651.7E-XS interface plates

Electrode holders with stainless steel base plate, incl. aluminium-insert for shaft collets of miscellaneous diameters.

Article no.	Article	Quantity	Weight	Code
FT 01227	FTool holder Ø 10 mm D40/M6	Set of 10 pieces	5.06 kg	A
FT 01228	FTool holder Ø 12 mm D40/M6	Set of 10 pieces	5.06 kg	A
FT 01229	FTool holder Ø 16 mm D40/M6	Set of 10 pieces	5.00 kg	A
FT 01230	FTool holder Ø 20 mm D40/M6	Set of 10 pieces	4.93 kg	A
FT 01316	FTool holder Ø 26 mm D40/M6	Set of 10 pieces	5.00 kg	A
FT 01231	FTool holder Ø 30 mm D40/M6	Set of 10 pieces	4.75 kg	A
FT 01232	FTool holder mixed set D40/M6, of 2 x Ø 10 / 12 / 16 / 20 / 26 mm	Set of 10 pieces	5.00 kg	A

Delivered without chucking spigot and without interface IF3R.

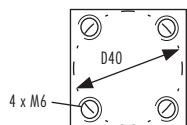

### Electrode holder

Brazen electrode holder with hole pattern 4 x M6 on pitch circle 40 mm. For the assembling of IF3R reference elements.

Article no.	Article	Quantity	Weight	Code
FT 01912	Uniholder 20 D40 M6 with slot width 20 mm	1 piece	0.48 kg	B
FT 01913	Prisround 25 D40 M6 with opening 25 x 25 mm	1 piece	0.48 kg	B

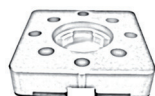

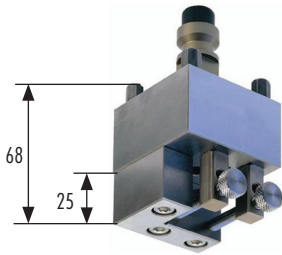

**V-block holder stainless**

Specification: Hardened and grinded surface of prism, 10 mm +/- 0.005 mm out of the centre.

Application: Clamp of electrodes with accurate machined shank.

Article no.	Article	Quantity	Weight	Code
FT 01087	V-block holder stainless EWIS	1 piece	1.10 kg	A

**Delivered with chucking spigot F/A EDM FT 01073.**



**UniV holder**

For the flexible clamping of round and square electrodes.

Article no.	Article	Quantity	Weight	Code
FT 01127	FTool UniV holder 58 x 80 mm ER	1 piece	1.60 kg	A
FT 01128	FTool UniV holder 58 x 80 mm IF3R	1 piece	1.94 kg	A

**Delivered without chucking spigot.**

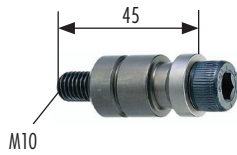

**Chucking spigot F/M EDM**

Version: Fixed type, manual. Bolt, length 45 mm, with flushing hole.

Application: In ITS electrode holders.

Article no.	Article	Quantity	Weight	Code
FT 01072	Chucking spigot F/M EDM manual with flushing	Set of 10 pieces	0.83 kg	A

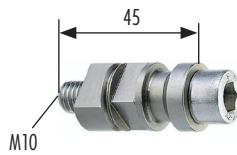

**Chucking spigot F/A EDM**

Version: Fixed type, automatic. Bolt, length 45 mm, with flushing hole.

Application: On all electrode holders that are changed automatically.

Article no.	Article	Quantity	Weight	Code
FT 01073	Chucking spigot F/A EDM automatic with flushing	Set of 10 pieces	0.72 kg	A

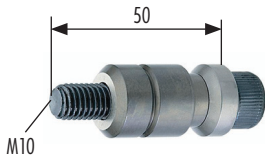

**Chucking spigot F/M long without flushing**

Version: Fixed type, manual. Bolt 12.9, length 50 mm, without flushing hole.

Application: In pallets for chip-cutting machining processes.

Article no.	Article	Quantity	Weight	Code
FT 01074	Chucking spigot F/M long without flushing	Set of 10 pieces	0.91 kg	A

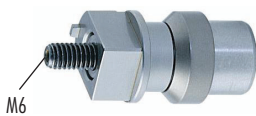

**Compact chucking spigot combi**

Application: To accommodate all the compact electrodes and electrode holders in ITS compact-combi chucks and electrode changers. For handling with the EROWA combi gripper.

Article no.	Article	Quantity	Weight	Code
FT 01089	Compact chucking spigot combi	Set of 10 pieces	0.53 kg	A

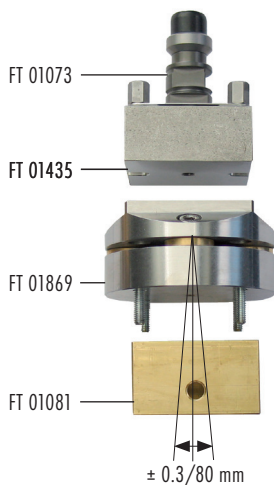

**F-Tool EDM swivel head Ø 72 mm**

The F-Tool swivel head can be adjusted independently in levels. Made of corrosion-resistant, hardened stainless steel. The swivel head can be utilized as a pendulum holder on the EDM machines and the wire EDM machines.

Article no.	Article	Quantity	Weight	Code
FT 01869	FTool EDM swivel head Ø 72 mm	1 piece	0.96 kg	A

**All EROWA standard holder can be assembled on the EDM swivel head Ø 72, after removal of the centering plate 50.**

**Installation examples, see p. 26.**

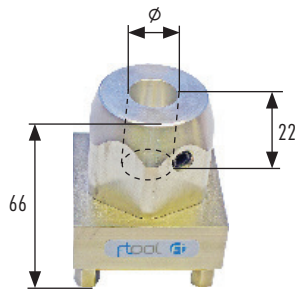

**F-Tool holder with EROWA interface**

Electrode holder, equipped with the repeat accurate ITS centering plate 50, assembled on the premium, stainless high-grade steel-basis plate. Incl. aluminium application for the shaft collet of divers diameters. Adapted for clamping of copper- and graphite blanks and for high-precision handling of electrodes in the ITS clamping system and for the following application on the EDM plant.

The length of H = 66 mm has the advantage of an optimal sight when setting up and that shorter electrodes can be inserted, so the barrel chuck doesn't dip into the dielectric fluid.

Article no.	Article	Quantity	Weight	Code
FT 01104	FTool holder ∅ 10 mm ER	Set of 10 pieces	5.60 kg	A
FT 01105	FTool holder ∅ 10 mm EWIS	Set of 10 pieces	5.60 kg	A
FT 01106	FTool holder ∅ 12 mm ER	Set of 10 pieces	5.60 kg	A
FT 01107	FTool holder ∅ 12 mm EWIS	Set of 10 pieces	5.60 kg	A
FT 01108	FTool holder ∅ 16 mm ER	Set of 10 pieces	5.50 kg	A
FT 01109	FTool holder ∅ 16 mm EWIS	Set of 10 pieces	5.50 kg	A
FT 01110	FTool holder ∅ 20 mm ER	Set of 10 pieces	5.40 kg	A
FT 01111	FTool holder ∅ 20 mm EWIS	Set of 10 pieces	5.40 kg	A
FT 01112	FTool holder ∅ 26 mm ER	Set of 10 pieces	5.30 kg	A
FT 01113	FTool holder ∅ 26 mm EWIS	Set of 10 pieces	5.30 kg	A
FT 01114	FTool holder ∅ 30 mm ER	Set of 10 pieces	5.30 kg	A
FT 01115	FTool holder ∅ 30 mm EWIS	Set of 10 pieces	5.30 kg	A
FT 01116	FTool holder mixed set ER, of 2 x ∅ 10 / 12 / 16 / 20 / 26 mm	Set of 10 pieces	5.50 kg	A
FT 01117	FTool holder mixed set EWIS, of 2 x ∅ 10 / 12 / 16 / 20 / 26 mm	Set of 10 pieces	5.50 kg	A

ER = EROWA basis **without** EWIS preparation. EWIS = EROWA basis **with** EWIS preparation.

**Delivered without chucking spigot.**

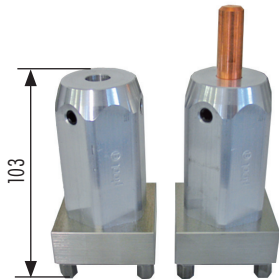

**F-Tool holder ∅ X mm EWIS special length**

Electrode holder, equipped with the repeat accurate ITS centering plate 50, assembled on the premium, stainless high-grade steel-basis plate. Incl. aluminium application for the shaft collet of divers diameters.

→ On customer request.

Article no.	Article	Quantity	Weight	Code
FT 01683	FTool holder ∅ X mm EWIS special length	Set of 10 pieces	6.75 kg	A

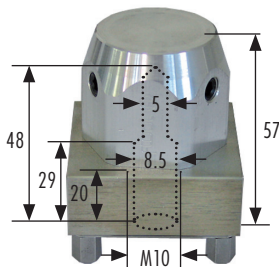

**F-Tool holder ER without hole**

The holder is prepared with lateral clamping screws M6. The central drill can be bored up optionally.

- Delivered without chucking spigot.

Article no.	Article	Quantity	Weight	Code
FT 01461	FTool holder ER without hole	Set of 10 pieces	5.63 kg	A
FT 01473	FTool holder D40 without hole / 6 x M6	Set of 10 pieces	5.10 kg	A

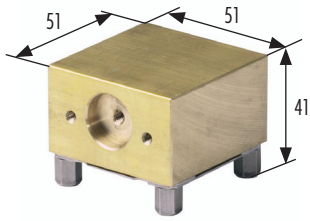
**Uniblank**

Version: Fitted without machining of body.  
 Application: To mount electrodes and workpieces of various shapes.  
 To fit blank: As required.

Article no.	Article	Quantity	Weight	Code
FT 01077	Uniblank <b>without</b> EWIS preparation	Set of 10 pieces	6.90 kg	A
FT 01078	Uniblank <b>with</b> EWIS preparation	Set of 10 pieces	6.70 kg	A

**Delivered without chucking spigots.**

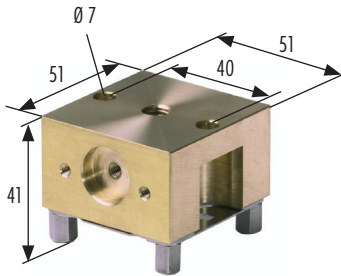
**Uniplate**

Version: Surface 51 x 51 mm faced, including 2 x M6 bolts for each unit.  
 Application: To mount electrodes and workpieces with a base surface of more than 50 mm.  
 To fit blank: With 2 x M6 bolts into the base surface.

Article no.	Article	Quantity	Weight	Code
FT 01079	Uniplate <b>without</b> EWIS preparation	Set of 10 pieces	5.80 kg	A
FT 01080	Uniplate <b>with</b> EWIS preparation	Set of 10 pieces	5.70 kg	A

**Delivered without chucking spigots.**

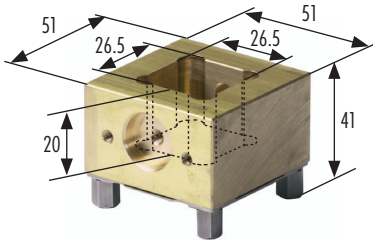
**Prisround**

Version: Square 26.5 mm milled. Including 2 setscrews for each unit.  
 Application: To mount electrodes and workpieces with a base surface of more than 50 mm.  
 To fit blank: Insert and tighten setscrews. If necessary, center with spacer plate FT 01092.

Article no.	Article	Quantity	Weight	Code
FT 01081	Prisround <b>without</b> EWIS preparation	Set of 10 pieces	5.60 kg	A
FT 01082	Prisround <b>with</b> EWIS preparation	Set of 10 pieces	5.40 kg	A

**Delivered without chucking spigots.**

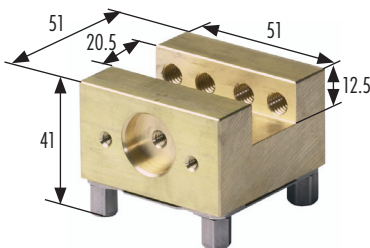
**Uniholder**

Version: Groove 20 mm faced. Including 2 setscrews for each unit.  
 Application: To mount electrodes and workpieces with shaft sizes of up to 20 mm.  
 To fit blank: Insert and tighten setscrews. If necessary, center with spacer plate FT 01092.

Article no.	Article	Quantity	Weight	Code
FT 01084	Uniholder <b>without</b> EWIS preparation	Set of 10 pieces	5.60 kg	A
FT 01083	Uniholder <b>with</b> EWIS preparation	Set of 10 pieces	5.50 kg	A

**Delivered without chucking spigots.**

**F-Tool ER adapter**

This adapter plate is overwinded parallel in the system and provides an insertion of electrodes, work pieces and appliances.  
 Corrosion-resistant.  
 Hole distance with 2 x M6 screws: 40 mm

Article no.	Article	Quantity	Weight	Code	Price CHF
FT 01435	FTool ER-plate EWIS	Set of 10 pieces	4.50 kg	A	660.00

**Collet chuck holder with EROWA interface**

Specification: Parameter EROWA ITS 50 or on 3R basis element.  
 Application: For collet chucks ETS32. Collet chuck Look at p. 21.

Article no.	Article	Quantity	Weight	Code
FT 01085	FTool collet chuck holder ETS32 / EWIS	1 piece	1.16 kg	A
FT 02017	Acorn nut M40 x 1.5 mm ETS32	1 piece		B

**Delivered with chucking spigot F/A EDM FT 01073 without EWIS chip FT 01170.**

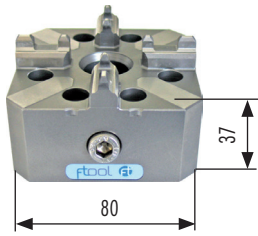

**ER chuck 80P**

Manual ER chuck. Hardened, stainless steel.  
 For the system sizes ER 50 and 100. Hole pattern ER chuck: 8 x M6 TK Ø 61 x 45°  
 Grinded taper for the power centering. Strong floating clamping mechanism.  
 Tension force by hand with Allen key: 8'000 N

Article no.	Article	Quantity	Weight	Code
FT 01043	FTool ER chuck 80P	1 piece	1.60 kg	A

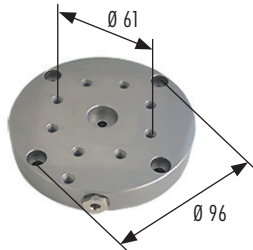

**EDM adapter plate**

Parallel grinded, stainless adapter plate for EDM quills. With flushing connection and M6 thread for power cable.  
 Dimension: Ø 110 x 18 mm  
 Hole pattern for chuck: 8 x M6 TK Ø 61 x 45°  
 Hole pattern for quill: 4 x 6.5 TK Ø 96 x 90°

Article no.	Article	Quantity	Weight	Code
FT 01236	EDM adapter plate Ø 110 mm chuck 80/PIN chuck	1 piece	1.32 kg	A
FT 01829	EDM adapter plate Ø 110 mm without hole pattern Ø 96 mm	1 piece	1.32 kg	A

Delivered with screws and flushing seal.

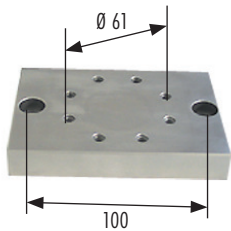

**Adapter plate**

Parallel grinded, stainless adapter plate, suited for machine tool tables.  
 Dimension: 120 x 82 x 18 mm  
 Hole pattern collet chuck: 8 x M6 TK Ø 61 x 45°  
 Collet machine tool table: with brackets or 2 x M8 distance 100 mm

Article no.	Article	Quantity	Weight	Code
FT 01336	Adapter plate 120 x 82 mm chuck 80/PIN chuck	1 piece	1.40 kg	A

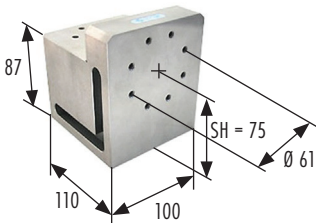

**Square block**

Accurate grinded square block, rustless, for the assembling of one or two ER chuck 80P (FT 01043), chuck 80 IF3R (FT 01044) or PIN center chuck (FT 01716) in vertical or horizontal position.  
 For the application with brackets on divers tooling machines.  
 Spindle height at horizontal installation of the chuck: 75 mm

Article no.	Article	Quantity	Weight	Code
FT 01483	Square block chuck 80/PIN chuck	1 piece	8.20 kg	A

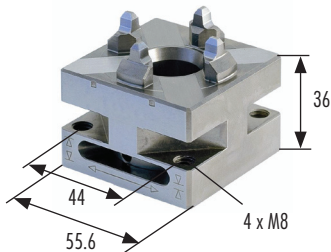

**F-Tool quickchuck ITS 50**

Version: ITS chuck system size 50, manual, stainless.  
 Attachment: 4 x M8 bolts from the rear or 4 x M6 stud bolts with nuts.  
 Application: On EDM/WEDM centers for light milling and grinding work. Max. revolutions on rotating axes 200 min<sup>-1</sup>.  
 Note: Clamping power 4'000 N.

Article no.	Article	Quantity	Weight	Code
FT 01041	FTool quickchuck ITS 50	1 piece	0.72 kg	B



**Extension Quickchuck 50**

Extension Quickchuck 50 of stainless steel.

Article no.	Article	Quantity	Weight	Code
FT 01768	Extension quickchuck 50 / L = 100 mm	1 piece	1.55 kg	B
FT 01769	Extension quickchuck 50 / L = 200 mm	1 piece	3.74 kg	B

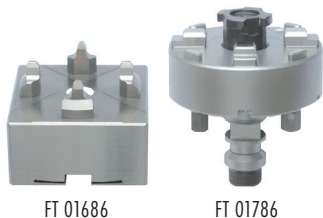

**Adapters EROWA-IF3R/IF3R-EROWA**

The adapters are aligned in the area of 0.01 mm to the original system.  
 System of stainless, hardened steel.

Article no.	Article	Quantity	Weight	Code
FT 01686	FTool system adapter IF3R Macro / ITS 50	1 piece	0.61 kg	B
FT 01786	FTool system adapter ITS 50 / IF3R	1 piece	0.93 kg	B

# F-Tool EDM tooling system

F-Tool delivers you from now on prefabricated blank electrodes and budget line EDM tooling systems of high quality.

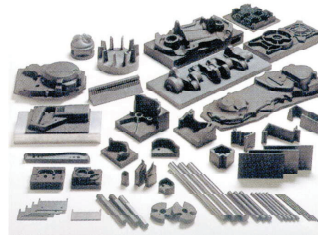

## EROWA EDM licence products p. 4



FT 01077  
FT 01078

FT 01079  
FT 01080

FT 01081  
FT 01082

FT 01083  
FT 01084

## H-link\*



FT 01999

FT 02000

FT 02001

FT 02002

## EROWA link

## 3R-link\*

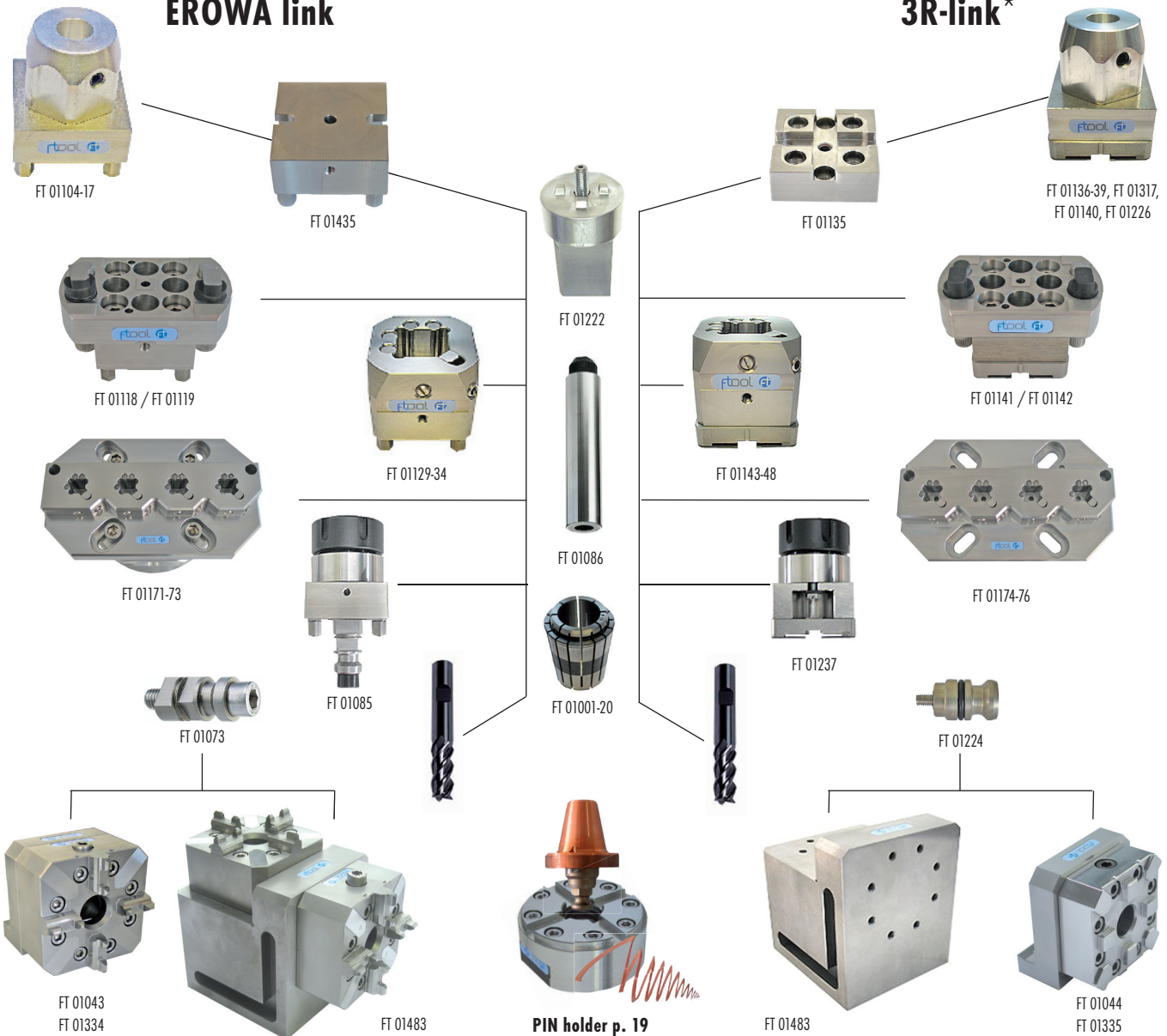

\*H-link = compatible with Hirschmann

\*3R-link = compatible with 3R

